

CE FCC RoHS

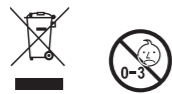

Shenzhen Retevis Technology Co.,Ltd.

Add: 7/F, 13-C, Zhonghaixin Science&Technology Park, No.12 Ganli
6th Road, Jihua Street, Longgang District, Shenzhen, China

Web: www.retevis.com

E-mail: kam@retevis.com

Facebook: facebook.com/retevis

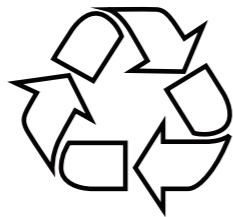

MADE IN CHINA

RETEVIS

RA27 VHF Marine Radio Instruction Manual

(EN)



TO USER

Thank you for purchasing this VHF DSC marine transceiver. You will find the professional and human oriented design of the transceiver during use. Please read all instructions carefully and completely before using the transceiver.

The transceiver is based on the technical characteristics of CCIR 493-4 and the operational characteristics of CCIR 541-3 of the International Radio Consultative Committee, and the resolutions of the International Telecommunication Union ITU-R Recommendation A.803(19), complying with national regulations and combined with practical use, a versatile Class B VHF DSC marine transceiver, it has dedicated DSC receiving channel.

This transceiver adopts advanced waterproof technology and has excellent waterproof performance.

PRECAUTIONS

- Never use the distress call when your ship or personnel is not in an emergency.
- Do not install the transceiver in hot, humid and dusty areas.
- The working voltage for the transceiver is 13.8V DC. If the power supply is 24V DC, please use a power converter (24V converts to 13.8V), or the transceiver won't work.
- Never directly connect to 220V AC power supply, this will ruin the transceiver. If an abnormal odor or smoke is detected coming from the transceiver, turn off the power immediately.
- Do not transmit before connecting the antenna, it will ruin the transceiver.
- After long time use, the heating panel becomes hot, this is normal state.

NOTE: This transceiver is divided into built-in GPS receiving module and no built-in GPS receiving module. The two versions are optional and the instructions are general.

CONTENTS

PREPARATION

Supplied Accessories.....	1
Transceiver Mounting.....	1
Antenna Connection.....	2
Installation of Connecting Cables.....	2
Dimensions	4

PANEL DESCRIPTION

Front Panel.....	5
Softkeys.....	6
Microphone	7
Function Display.....	8

BASIC OPERATION

Power ON/OFF	10
Transmitting and Receiving.....	10
Channel Group Selection.....	11
Channel Selection.....	11
Call Channel Programming.....	12
Channel Name.....	13
Display Backlight.....	13
Display Contrast	13
Vibration Water Draining Function.....	14
Microphone Lock Function.....	14

SCAN OPERATION

Scan Types	15
Setting TAG Channels	15
Starting a Scan.....	16

DUALWATCH / TRI-WATCH

Description	17
Operation.....	17

DSC OPERATION

MMSI Code Programming.....	18
ATIS ID Programming.....	19
DSC Address ID	19
Distress Call	23
Individual Call	27
Group Call	30
All Ships Call.....	32
Position Request Call / Polling Request Call.....	33
Test Call	36
DSC Log.....	40
Multiple-task Mode	41

MENU SCREEN OPERATION

Menu Screen Operation	43
Menu Screen Items	43
Radio Settings.....	45
Configuration	46

VHF MARINE RADIO CHANNEL LIST (Default USA)

SPECIFICATIONS

TROUBLESHOOTING

PREPARATION

■ Supplied Accessories

The following accessories are supplied:

ITEM	QTY.
DC Power Cable	1
Spare Fuse	1
Mounting Bracket	1
Mounting Screws Package	1
Instruction Manual	1
GPS Antenna (For Model with GPS Only)	1

■ Transceiver Mounting

◇ Using the Supplied Mounting Bracket

The universal mounting bracket supplied with your transceiver allows overhead or dashboard mounting.

1. Fix the mounting bracket to overhead or dashboard with the supplied screws and mount the transceiver to the mounting bracket with the knob bolts.
2. Adjust the transceiver so that the face of the transceiver is at 90° to your line of sight when operating it and tighten the knob bolts so that the transceiver is securely mounted.

NOTE: You may use a spongy cushion between the transceiver and mounting bracket to reduce the impact of vibration.

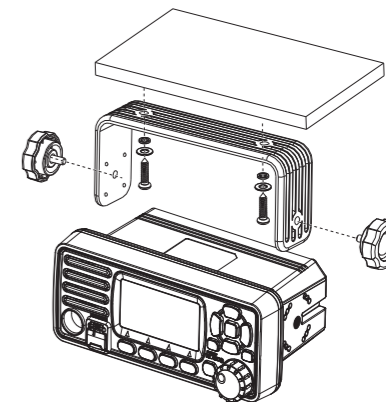

■ Antenna Connection

Please connect an antenna before transmitting. Select the antenna with the corresponding frequency and install on the ANT antenna base. Use the antenna and coaxial feeder with the same natural impedance 50Ω.

NOTE: Do not transmit before connecting the antenna, it will ruin the transceiver.

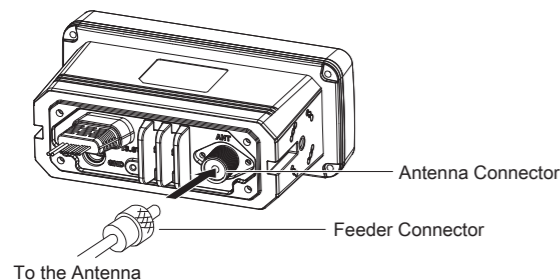

■ Installation of Connecting Cables

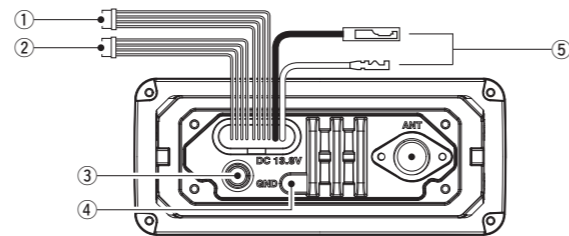

When connecting the external speaker, GPS, DC power supply, computer and navigation device by the rear panel cable end, cover the connectors and cables with rubber vulcanizing tape as below, to prevent water seeping into the transceiver.



1. External Speaker and Programming Data Leads

- Connect an external speaker to Blue and Black Lead. Blue→Positive Electrode (+), Black→Negative Electrode (-).
- Connect programming cable to Orange and Grey Lead.

2. NMEA In/Out Leads

Through the rear panel lead, this transceiver can connect GPS input signals from GPS receivers, and can also output GPS signals to other devices.

- **Input Connection:** Connect to the NMEA output line (port)

of the GPS receiver for location data, connect as follows: Green→Receiving Data, GPS Input (-); Yellow→Receiving Data, GPS Input (+).

NOTE: GPS receiver is required to be compatible with NMEA0183 version 2.0 or above, statement format RMC, GGA, GNS, GLL.

- **Output Connection:** Connect the output to the navigation device input line (port) that supports NMEA0183 for receiving location data from other ships, connect as follows: Brown→Sending Data, Data Output (-); White→Sending Data, Data Output (+).

NOTE: The output signal of this transceiver complies with NMEA0183 version 2.0 or above, compatible with DSC, DSE navigation equipment, statement format RMC, GSA, GSV.

3. External GPS Antenna

Connect to an external GPS antenna. This interface is only available on models with GPS, and is not available on models without GPS.

NOTE: Make sure that the GPS antenna is installed in an open, unobstructed position so that the satellite signal can be received well. When installing the GPS antenna, use the supplied double-sided tape to fix it.

4. Ground Terminal

Connect this terminal to a vessel ground to prevent electrical shocks and interference from other equipment occurring. Use a PH M3×6 mm screw (not supplied).

5. DC Power Connector

Red - Positive(+), Black - Negative(-).The output voltage of the connected DC power supply must be 13.8V, do not connect the transceiver to the 24V storage battery. If the current supplied to the transceiver is insufficient, the display may darken during transmission or the transmitting output power may drop significantly.

NOTE: Connect the DC power cable to the 13.8V DC power supply. Notice that the positive and negative polarity of the terminal should be connected correctly.

◇ Connected to the ship's main power source AC220V

If the ship's main power supply AC220V/50Hz is to be used, a separate DC stabilized voltage power supply device is required, with an output voltage of 13.8V and an output current of 15A.

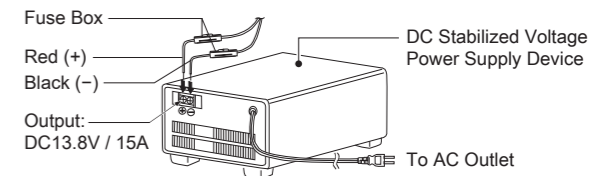

◇ Connect to ship's backup power DC24V

If the ship's backup power supply DC24V is to be used, a separate step-down power supply device (Input DC24V, Output DC13.8V / 15A) shall be used.

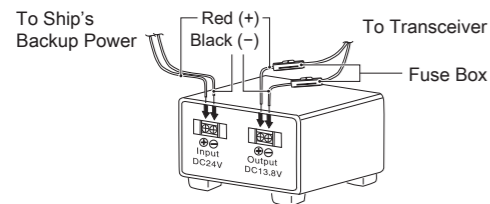

◇ Fuse Replacement

One fuse is installed in the supplied DC power cable. If a fuse blows or the transceiver stops functioning, track down the source of the problem first, then replace the damaged fuse with a new, rated one.

NOTE: Please power off transceiver before replacing the fuse, the required fuse is DC15A/32V.

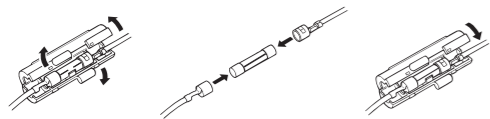

■ Dimensions

Unit: mm

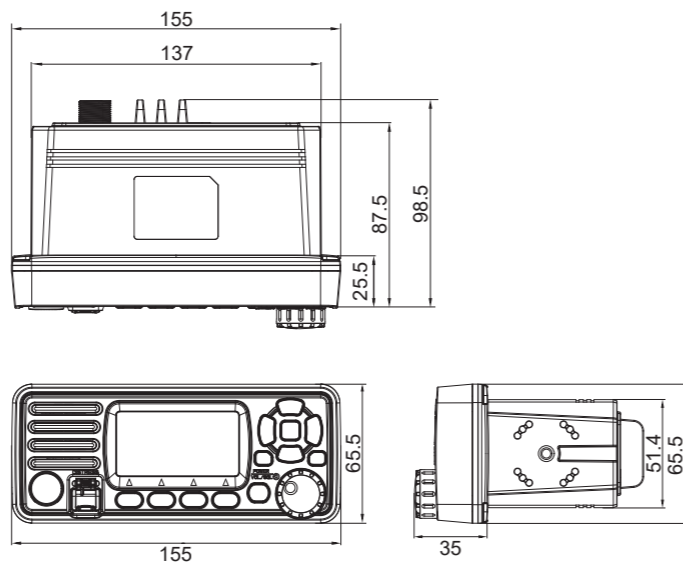

PANEL DESCRIPTION

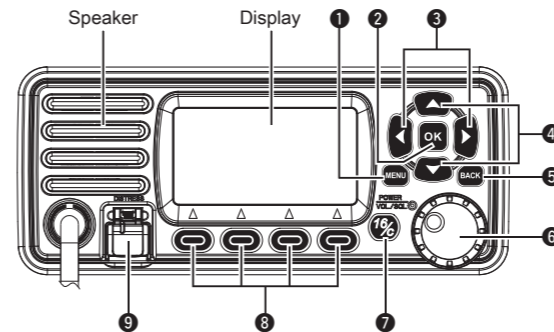

■ Front Panel



- 1 **Menu Key [MENU]**
 - Press this key to enter or exit the menu operation display interface.
- 2 **Enter Key [OK]**
 - Press this key to set the entered data, selected items, etc.
- 3 **Left/Right Keys [◀]/[▶]**
 - Press to scroll through the softkey functions.
 - Press to select a character or number in input mode.
- 4 **Up/Down Keys [▲]/[▼]**
 - Press to select work channel, menu items, menu settings, etc.
 - Press to select a character or number in the entry in input mode.

- 5 **Clear Key [BACK]**
 - Press to cancel the settings, or exit the DSC menu.
- 6 **Power/ Volume/ Squelch Knob [PWR/VOL/SQL]**
 - Press and hold for one second to power ON/OFF the transceiver.
 - Rotate or press to enter the volume setting display interface, then rotate to adjust the volume.
 - Press twice to enter the squelch level setting display interface, then rotate to adjust the squelch.
 - In the menu interface, rotate to select menu items.
 - In input mode, press to select a character or number, and rotate to move the cursor.
- 7 **Channel 16 / Call Channel Key [16/C]**
 - Press to select Channel 16.
 - Press and hold for one second to select Call Channel (Default Channel 9).
 - "CALL" appears when the Call channel is selected.
- 8 **Softkeys [⏏]**
 - Press [◀] or [▶] to scroll through the key functions at the bottom of the display, then press the 4 softkeys [⏏] to select the key function.
 - The definition of the softkeys is described in the following description.
- 9 **Distress Key [DISTRESS]**
 - Open the cover, press and hold this key for 3 seconds to transmit a Distress call.



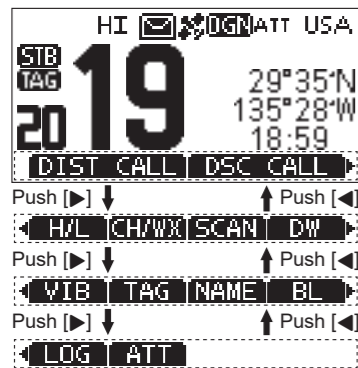

Softkeys

Various often-used functions are assigned to the softkeys [] for easy access. The functions' icons are displayed above the softkeys [], as shown below.



NOTE: The displayed icons or their order may differ, depending on the presetting by programming software. When the MMSI code is not set, the softkeys for DSC function are not displayed.

Using the Softkeys

Press [] or [] to scroll through the selectable functions that are assigned to the softkeys []. Press the softkeys [] under the functions's icon to select the function.

Softkey Functions

The softkey functions that can be implemented are as follows:

1. Distress Call []

Press to display the "DISTRESS" screen, to select the Nature of distress, then to make a call.

- "  " is displayed in the Multiple-task mode.

NOTE: NEVER make a distress call if your ship or a person is not in an emergency. A distress call should be made only when immediate help is needed.

2. Other DSC []

Press to select DSC CALL, including Individual Call, Group Call, All Ships Call, Test Call.

- "  " is displayed in the Multiple-task mode.

3. Task List []

Press to display Task List.

- It is displayed in the Multiple-task mode.

4. Scan []

Press to start or stop Normal Scan or Priority Scan.

5. Dualwatch/Tri-watch []

Press to start or stop Dualwatch/Tri-watch.

6. High/Low Power []

Press to set output power to high or low.

- Some channels are set to low power only.

7. Channel/Weather Channel []

Press to select regular channels or Weather Channel.

- The Weather Channel is for USA and Australian versions only. "  " is displayed for other versions.
- While the Call channel or Channel 16 is displayed, press this key to return to regular channel mode.

8. Attenuation []

Press to turn the Attenuator ON or OFF.

9. Vibration Water Draining []

Press and hold this key to turn ON Vibration Water Draining function to clear water from the speaker grill.

10. Favorite Channel []





Press to set or release the displayed channel as a Favorite Channel.

- Press to set current untagged channel as TAG channel; Press again to clear the TAG channel.

11. Channel Name []

Press to edit the name of the displayed channel.

12. Backlight []

Press to enter display and keypad backlight brightness adjustment mode, press []/[], []/[] keys or rotate [] knob to adjust display and keypad backlight brightness.

- 8 levels of baklight brightness: 1~7, OFF.

13. Log []

Press to display received call log or distress message log.

Microphone

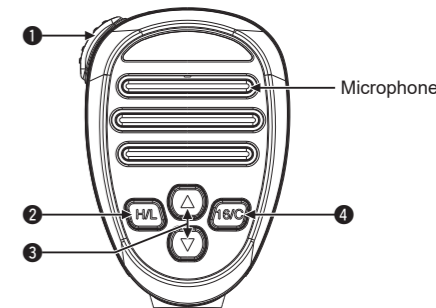



1 PTT Switch []

- Press and hold to transmit; Release to receive.

2 Transmit Power Key []

- Press to select high or low output power. Some channels are set to low power only.
- While pressing and holding [], power ON to toggle the microphone lock function ON or OFF.

3 Channel []/[] Keys

- Press to select operating channel, Set mode setting etc.
- When the favorite channel function is activated, press []/[] keys to select the favorite channels in the selected channel group in sequence.

4 Channel 16 / Call Channel Key []

- Press to select Channel 16.
- Press and hold for one second to select Call Channel (Default Channel 9). "  " appears when the Call channel is selected.

■ Function Display

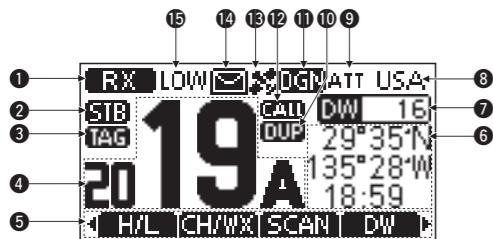

No.	Name	Descriptions
1	Signal Status Indicator	<ul style="list-style-type: none"> • “RX” displayed while receiving. • “TX” displayed while transmitting.
2	Status Indicator	<ul style="list-style-type: none"> • “STB” displayed when in the standby mode. • “R/T” displayed when the channel is changed while receiving or transmitting a signal.
3	Favorite Channel Icon	<ul style="list-style-type: none"> • “TAG” displayed when the Favorite channel is selected.
4	Operating Channel Number	<ul style="list-style-type: none"> • Displays the selected operating channel number, can display 4 digits channel number. • “A” or “B” is displayed when a simplex channel is selected.

No.	Name	Descriptions
5	Softkeys Function Display	<ul style="list-style-type: none"> • The functions of softkeys are displayed.
6	Position/Time Readouts	<ul style="list-style-type: none"> • Readouts the current position and time when valid GPS data is received or when manually input. • “NO POS NO TIME” is displayed if no GPS data has been received, and then a warning message is displayed for 2 minutes after turning ON the transceiver. • “??” blinks if no GPS data is received for 30 seconds after receiving valid GPS data, and then “??” and a warning message are displayed after 10 minutes. • A warning message is displayed if no GPS data is received for 4 hours after receiving valid GPS data. • A manually input GPS data is valid for 23.5 hours, and then a warning message is displayed.
7	Scan Indicator	<ul style="list-style-type: none"> • “SCAN 16” is displayed while Priority Scan, “SCAN” is displayed while Normal Scan. • “DW 16” is displayed while Dualwatch, “TW 16” is displayed while Tri-watch.

No.	Name	Descriptions
8	Channel Group Indicator	<ul style="list-style-type: none"> • “USA” is displayed when USA channel group is selected. • “INT” is displayed when International channel group is selected. • “CAN” is displayed when Canada channel group is selected. • “WX” is displayed when Weather channel group is selected. When the WX-Alert is set to ON, “WX” is displayed instead of “WX”.
9	Attenuator Icon	<ul style="list-style-type: none"> • “ATT” is displayed when RF attenuation is ON.
10	Duplex Channel Indicator	<ul style="list-style-type: none"> • “DUP” is displayed when a Duplex channel is selected.
11	GPS Status Icon	<ul style="list-style-type: none"> • GP: GPS; GN: GPS+GLONASS; DGP: SBAS+GPS; DGN: SBAS+GPS+GLONASS
12	Call Channel Indicator	<ul style="list-style-type: none"> • “CALL” is displayed when a Call channel is selected.
13	GPS Positioning Icon	<ul style="list-style-type: none"> • Displayed when valid GPS position data (Including GPS and GLONASS) is received. • Blinks when received GPS position data is invalid.
14	Message Icon	<ul style="list-style-type: none"> • “ ” is blinked when there is an unread DSC message, “ ” disappears when the message has been read.

No.	Name	Descriptions
15	Output Power Icon	<ul style="list-style-type: none"> • “HI” is displayed when high power is selected. • “LOW” is displayed when low power is selected.

BASIC OPERATION

■ Power ON/OFF

1. Press and hold [PWR] knob for 1 second to power ON.
2. Press and hold [PWR] knob for 1 second again to power OFF.

■ Transmitting and Receiving

◇ Transmitting

1. Press [H/L] key on the microphone to select the output power if necessary.
 - “LOW” appears when low power is selected.
 - Choose low power for short range communication, choose high power for longer distance communication.
 - Some channels are with low power only.
2. Press and hold [PTT] key to transmit, then speak into the microphone.
 - “TX” appears.
 - CH70 is for DSC transmitting only.
3. Release [PTT] to receive.

NOTE: Do not transmit before connecting the antenna, this will ruin the transceiver.
If the TOT function is enabled by the PC programming software, the transmission time-limited protection function prohibits continuous transmission for a long time.

◇ Receiving

Volume Adjustment:

1. Rotate [VOL] knob to adjust the volume, volume adjustment interface is displayed.

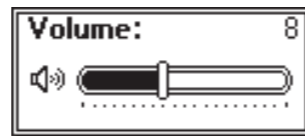

2. If no key is pressed within 5 seconds, the interface will automatically exit.

Squelch Level Adjustment:

1. Press [SQL] knob twice, squelch level adjustment interface is displayed.
2. Rotate [SQL] knob to adjust the squelch level.

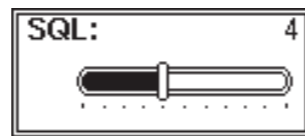

3. If no key is pressed within 5 seconds, the interface will automatically exit.

■ Channel Group Selection

Channel Groups are preset into this transceiver.

1. Press [MENU] key, the menu interface is displayed.
2. Press [▲]/[▼] or rotate [DIAL] knob to select “Radio Settings”, then press [OK], the “RADIO SETTINGS” screen is displayed.
3. Press [▲]/[▼] or rotate [DIAL] knob to select “Channel Group”, then press [OK], the “CHANNEL GROUP” screen is displayed.
4. Press [▲]/[▼] or rotate [DIAL] knob to select a Channel Group, then press [OK], the selected Channel Group Icon is displayed on the operating screen. Press [EXIT] to exit the menu screen.

■ Channel Selection

◇ Regular Channel

Press [▲]/[▼] to select regular channel.

◇ Channel 16

Channel 16 is the distress and safety channel. It is used for establishing initial contact with a station and for emergency communications. Channel 16 is monitored during both Dualwatch and Tri-watch.

1. Press [16/C] to select Channel 16.
2. Press [◀]/[▶] to display [CH/WX], then press the softkey below [CH/WX], to return to the previously selected channel.

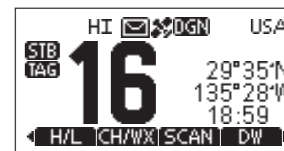

◇ Call Channel

Each regular channel group has a separate leisure-use Call channel (Default Channel 9). The Call channel is monitored during Tri-watch.

1. Press and hold [16/C] for 1 second to select the Call channel of the selected channel group. “CALL” and Call channel number appear.
2. Press [◀]/[▶] to display [CH/WX], then press the softkey below [CH/WX], to return to the previously selected channel. Press [▲] or [▼] to select channel.

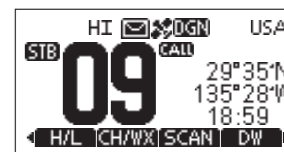

◇ Weather Channels

The transceiver has 10 weather channels.

The transceiver can automatically detect a weather alert tone on the selected weather channel while receiving on a regular channel or while scanning.

Selecting a Weather Channel

1. Press softkey [**CH/WX**] to select between weather channel and regular channel.
 - “WX” appears when a weather channel is selected.
 - When the WX-Alert is set to ON, “WX☁” is displayed instead of “WX”.
2. Press [▲] [▼] to select a Weather channel.

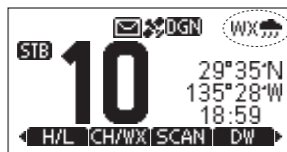

Setting the Weather Alert

1. Press [MENU] key, the menu interface is displayed.
2. Press [▲] [▼] or rotate [DIAL] knob to select “Radio Settings”, then press [OK], the “RADIO SETTINGS” screen is displayed.
3. Press [▲] [▼] or rotate [DIAL] knob to select “WX Alert”, then press [OK], the “WX ALERT” screen is displayed.
4. Select “On With Scan” or “On”, “WX☁” is displayed on screen.

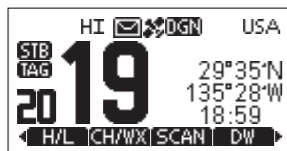

Call Channel Programming

Call channel is used to select Channel 9 (default), however, you can program the Call channel with your most offer-used channel in each channel group for quick recall.

1. Press [MENU] key, the menu interface is displayed.
2. Press [▲] [▼] or rotate [DIAL] knob to select “Radio Settings”, then press [OK], the “RADIO SETTINGS” screen is displayed.
3. Press [▲] [▼] or rotate [DIAL] knob to select “Call Channel”, then press [OK], the “CALL CHANNEL” screen is displayed.
4. Press [▲] [▼] or rotate [DIAL] knob to select the desired Call channel.
5. Press [OK] to confirm, the selected channel is set as Call channel.
6. Press softkey [**EXIT**] to cancel and exit.



Channel Name

Each channel can be assigned a name of up to 10 characters. Characters available for input: 26 uppercase letters, number 0~9, symbol (! " # \$ % & '()* +, - . / [] ^ _ ; < = > ?), SPACE.

1. Press [▲] [▼] to select the channel you want to edit.
 - Before setting, you should exit Dualwatch, Tri-watch or scan.
2. Press [◀] [▶] to display [**NAME**].
3. Press softkey [**NAME**], the “CHAN NAME” screen is displayed.



4. Select [**!\$?**] to input symbols, and select [**123**] to input numbers and letters.
5. Press [▲] [▼] [◀] [▶] to select characters or space.
6. Press [OK] to input the selected character.
7. Select “←” or “→”, or rotate [DIAL] to move the cursor.
8. Repeat steps 4~7 to input all the characters.
9. Press softkey [**EXIT**] to cancel editing.
10. Press softkey [**FIN**] to save the edited name and return to the operating screen.

Display Backlight

Backlight brightness of the LCD display and keypads can be set by this function, totally 7 levels of brightness and OFF optional.

1. Press [MENU] key, the menu interface is displayed.
2. Press [▲] [▼] or rotate [DIAL] knob to select “Configuration”, then press [OK], the “CONFIGURATION” screen is displayed.
3. Press [▲] [▼] or rotate [DIAL] knob to select “Backlight”, then press [OK], the “BACKLIGHT” screen is displayed.
4. Press [▲] [▼] or rotate [DIAL] knob to adjust the backlight brightness.
5. Press [OK] to confirm.
 - Press softkey [**EXIT**] to return to main interface.

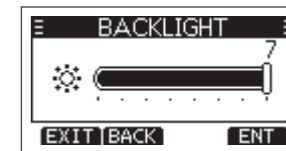

Display Contrast

LCD display contrast can be set by this function, totally 8 levels optional.

1. Press [MENU] key, the menu interface is displayed.
2. Press [▲] [▼] or rotate [DIAL] knob to select “Configuration”, then press [OK], the “CONFIGURATION” screen is displayed.
3. Press [▲] [▼] or rotate [DIAL] knob to select “Display Contrast”, then press [OK], the “CONTRAST” screen is displayed.

played.

4. Press [▲]\[▼] or rotate [DIAL] knob to adjust the display contrast.
5. Press [OK] to confirm.
 - Press softkey [EXIT] to return to main interface.

■ Vibration Water Draining Function

Vibration helps drain water away from the speaker housing (water that might otherwise muffle the sound coming from the speaker). The transceiver makes a vibrating noise when this function is being used.

NOTE: Do not use the vibration water draining function when connecting an external speaker.

1. Press [◀]\[▶] to display [VIB].
 - “VIB WATER” interface is displayed.
2. Press and hold softkey [VIB], the transceiver emits a low sound for draining.
3. Release softkey [VIB] to turn vibration water draining function OFF.

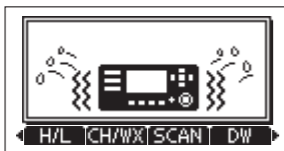

■ Microphone Lock Function

The microphone lock function electrically locks all keys except for [PTT] on the supplied microphone. This prevents accidental channel changes and function access.

1. Press and hold [DIAL] knob for one second to power OFF.
2. While pressing and holding [H/L] on the microphone, power ON to toggle the microphone lock function ON or OFF.

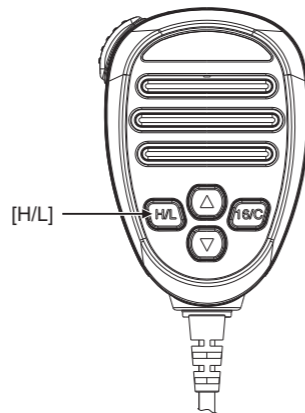

SCAN OPERATION

■ Scan Types

This transceiver has normal scan and priority scan, can be set in the menu item “Radio Settings”.

When the weather alert function is turned ON, the previously selected (last used) weather channel is also scanned. Set the TAG channels (scanned channels) before scanning. Clear the TAG channels which inconveniently stop scanning.

Normal Scan: Normal scan searches through all TAG channels in sequence. Channel 16 is not checked unless Channel 16 is set as a TAG channel.

Priority Scan: Priority scan searches through all TAG channels in sequence while monitoring Channel 16.

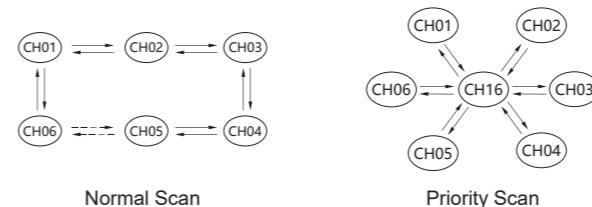

■ Setting TAG Channels

For more efficient scanning, you can add desired channels as TAG channels or clear the TAG for unwanted channels. Channels that are not tagged will be skipped during scanning.

◇ Setting / Clearing a Single Tagged Channel

1. Press [▲]\[▼] to select the channel you want to set as TAG channel.
2. Press [◀]\[▶] to display [TAG].
3. Press softkey [TAG] to set current channel as TAG channel.
 - “TAG” is displayed on screen.
4. To cancel the TAG channel setting, press softkey [TAG] again.
 - “TAG” is disappeared on screen.

◇ Setting / Clearing All Tagged Channels

1. Press [MENU] key, the menu interface is displayed.
2. Press [▲]\[▼] or rotate [DIAL] knob to select “Radio Settings”, then press [OK], the “RADIO SETTINGS” screen is displayed.
3. Press [▲]\[▼] or rotate [DIAL] knob to select “FAV Settings”, then press [OK], the “FAV SETTINGS” screen is displayed.
4. Press [▲]\[▼] or rotate [DIAL] knob to select “Set All Channels” to set all channels as Tagged Channels.
5. Select “Clear All Channels” to cancel all the TAG channel setting.
6. Select “Set Default” to restore to factory default channel setting.

■ Starting a Scan

Scan Type, Weather Alert, Scan Timer can be set in the menu interface.

1. Press [◀][▶] to display [SCAN].
2. Press softkey [SCAN] to start Normal or Priority Scan.
 - “SCAN 16” is displayed during a Priority Scan, and “SCAN” is displayed during a Normal Scan.
 - When a signal is received, the scan pauses until the signal disappears, or resumes after 5 seconds, depending on the Scan Timer setting in “Radio Settings”.
 - A beep sounds and “16” blinks when a signal is received on Channel 16 during a Priority Scan.
 - Press [▲][▼] to change the scanning direction.
3. To stop the scan, press softkey [SCAN] again.

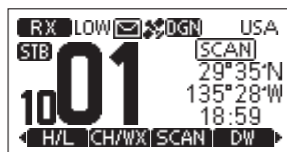

DUALWATCH / TRI-WATCH

■ Description

This transceiver has Dualwatch and Tri-watch.

Dualwatch monitors Channel 16 while you are receiving on another channel.

Tri-watch monitors Channel 16 and the Call channel while receiving on another channel.

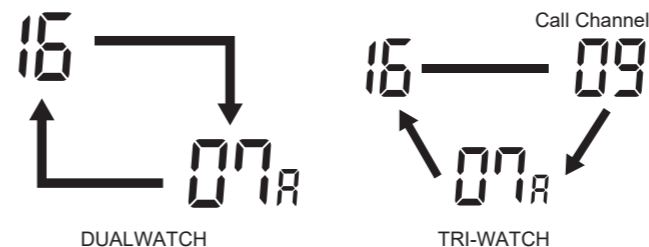

■ Operation

1. Press softkey [DW] to start Dualwatch or Tri-watch.
 - “DW 16” is displayed during Dualwatch; “TW 16” is displayed during Tri-watch.
 - A beep tone sounds when a signal is received on Channel 16.
 - Tri-watch converts to Dualwatch when a signal is received on Call channel.
2. Press softkey [DW] again to cancel Dualwatch or Tri-watch.



DSC OPERATION

■ MMSI Code Programming

The 9-digit MMSI (Maritime Mobile Service Identity: DSC self ID) code can be programmed by PC software and also manually set on this transceiver.

- Press and hold **[PWR]** knob to power ON.
 - Three short beeps sound, and “Push **[OK]** to Register your MMSI” is displayed.
- Press **[OK]** to start setting the MMSI code.
 - During the setup process, press **[BACK]** to skip the setting and return to normal operating mode, and you cannot make a DSC call.
- Enter the MMSI code:
 - Press **[◀] [▶]** to select the desired number.
 - Press **[OK]** to input the selected number.
 - Select “←” or “→”, or rotate **[DIAL]** to move the cursor, then press **[OK]**.

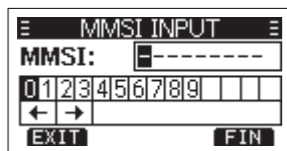

- Repeat step 3 to enter all 9 digits.
- After 9 digits have been input, press softkey **[FIN]** to set the code.

- Enter MMSI code again to confirm.

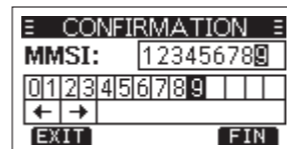

- Repeat step 3 to 5 as above.
 - When your MMSI code is successfully input, “MMSI Successfully Registered” is displayed as below.
 - After setting, this transceiver can perform normal operation.

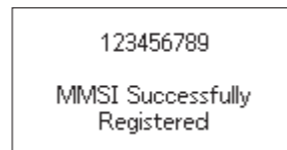

NOTE: In the menu interface, you can query the set MMSI code.

■ ATIS ID Programming

The Automatic Transmitter Identification System (ATIS) ID consists of 10 digits. You can enter the ATIS ID in the “ATIS ID Input” item on the Menu screen.

The ID entering can be done only once. After entering, it can be changed only by PC programming software.

- Press **[MENU]** key, the menu interface is displayed.
- Press **[▲] [▼]** or rotate **[DIAL]** knob to select “ATIS Setting”, then select “ATIS ID Input”, then press **[OK]**, the “ATIS ID Input” screen is displayed.
- Enter the ATIS ID:
 - Press **[◀] [▶]** to select the desired number.
 - Press **[OK]** to input the selected number.
 - Select “←” or “→” to move the cursor, then press **[OK]**.

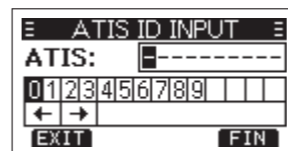

- Repeat step 3 to enter all 10 digits.
- After 10 digits have been input, press softkey **[FIN]** to set the ID.
- Enter ATIS ID again to confirm.

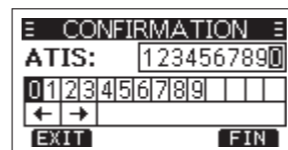

- Repeat step 3 to 5 as above.
 - After setting, this transceiver can perform normal operation.

NOTE: In the menu item “Radio Info”, you can query the set ATIS ID.

■ DSC Address ID

Before using the DSC call related function, the DSC can be set as follows:

- Press **[MENU]** key, the menu interface is displayed.
- Press **[▲] [▼]** or rotate **[DIAL]** knob to select “DSC Settings”.
- Press **[OK]**, the “DSC SETTINGS” screen is displayed.
- Press **[▲] [▼]** or rotate **[DIAL]** knob to select the submenu item you want to set up.
 - The setting items include Position Input, Individual ID, Group ID, Auto ACK, CH Auto SW, Data Output, Alarm Status, CH 70 SQL Level, Self-Test, Multi-Task.
- Press **[OK]** to enter next level menu.
- Press **[BACK]** or softkey **[BACK]** to return to the previous menu. Press softkey **[EXIT]** to return to main interface.

◇ Entering the Position and Time

A Distress call should include the vessel's position and time. If no GPS data is received, manually input the position and Universal Time Coordinated (UTC) time.

- The manual entry is disabled while valid GPS data is received.
 - The manually entered position and time is valid only for 23.5 hours, or until turning OFF the transceiver.
- Display the “POSITION INPUT” screen.

- Press **[▲][▼]/[◀]▶** to enter longitude and latitude.
 - Press **[◀]▶** to select desired number.
 - Press **[OK]** to enter.
 - Select "←" or "→", or rotate **[DIAL]** to move the cursor, then press **[OK]**.
 - Move cursor to "N" or "S" to select N (North Latitude) or S (South Latitude).
 - Move cursor to "W" or "E" to select W (West Longitude) or E (East Longitude).



- After position is input, press **[OK]** to confirm.
- In the UTC time editing interface, enter the UTC time as follows.
 - Press **[◀]▶** to select desired number.
 - Press **[OK]** to enter.
 - Select "←" or "→", or rotate **[DIAL]** to move the cursor, then press **[OK]**.

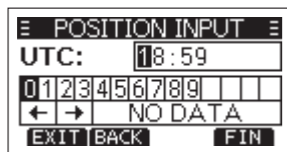

- Press softkey **[FIN]** to confirm position and time setting.
- Press softkey **[EXIT]** to return to standby interface.

- The entered position and time are displayed on the operating screen.

◇ Entering an Individual ID

You can enter a total of 60 Individual IDs, and assign names to them of up to 10 characters.

- Display the "INDIVIDUAL ID" screen.
 - "NO ID" is displayed if no ID is entered.
- Press softkey **[ADD]**, "INDIVIDUAL ID" entry screen is displayed.

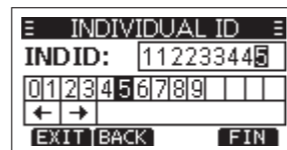

- Enter an Individual ID:
 - Press **[◀]▶** to select the desired number.
 - Press **[OK]** to input the selected number.
 - Select "←" or "→" to move the cursor, then press **[OK]**.
 - * The first digit is fixed as "0" for a Group ID.
 - * The first two digits are fixed as "0" for any coast station ID.
- Repeat step 3 to enter all 9 digits.
- Then press softkey **[FIN]** to start entering the name.

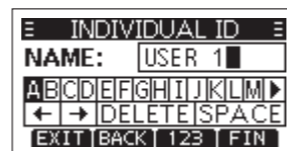

- Enter an Individual ID Name:
 - Press **[▲][▼]/[◀]▶** to select the desired characters.
 - Press **[OK]** to input the characters.
 - Select "←" or "→" to move the cursor, then press **[OK]**.
 - Press **[123]/[!\$?]/[ABC]** to select numbers, characters and letters.
- Then press softkey **[FIN]** to save, and return to the previous screen.
 - The entered Individual ID name is displayed.

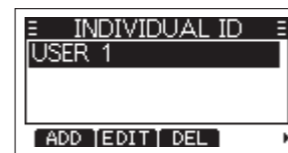

◇ Entering a Group ID

You can enter a total of 30 Group IDs, and assign names to them of up to 10 characters.

- Display the "GPURP ID" screen.
 - "NO ID" is displayed if no ID is entered.
- Press softkey **[ADD]**, "GROUP ID" entry screen is displayed.

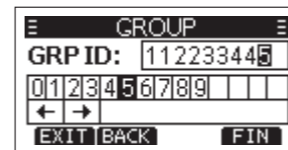

- Enter an Group ID:
 - Press **[◀]▶** to select the desired number.
 - Press **[OK]** to input the selected number.
 - Select "←" or "→" to move the cursor, then press **[OK]**.
 - * The first digit is fixed as "0" for a Group ID.
 - * The first two digits are fixed as "0" for any coast station ID.
- Repeat step 3 to enter all 9 digits.
- Then press softkey **[FIN]** to start entering the name.
- Enter an Group ID Name:
 - Press **[▲][▼]/[◀]▶** to select the desired characters.
 - Press **[OK]** to input the characters.
 - Select "←" or "→" to move the cursor, then press **[OK]**.
 - Press **[123]/[!\$?]/[ABC]** to select numbers, characters and letters.
- Then press softkey **[FIN]** to save, and return to the previous screen.
 - The entered Group ID name is displayed.



◇ Deleting an Entered ID

1. Display the "INDIVIDUAL ID" or "GPOUP ID" screen.
2. Press [▲][▼] to select the ID you want to delete, then press softkey [DEL].
 - You can edit an ID and its name by pressing [EDIT].

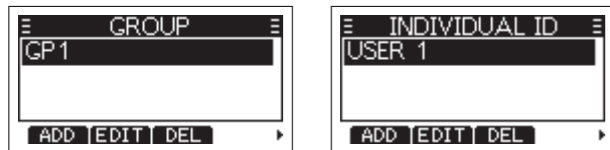

3. Then press [OK] delete ID, and return to the previous screen.
 - Press [CANCEL] to cancel the deletion.

◇ Auto Acknowledgement (Auto ACK)

The Auto ACK function automatically sends an Acknowledgement call when an appropriate request is received. Auto Acknowledgement includes: Individual ACK, Position ACK, Polling ACK, Test ACK, the corresponding Acknowledgement mode setting options are shown in the following table:

ACK Type \ ACK Mode	Auto (Able)	Auto (Unable)	Auto	Manual
Individual ACK	Auto (Able)	Auto (Unable)		Manual
Position ACK	Auto (Able)			Manual
Polling ACK			Auto	Manual
Test ACK			Auto	Manual

◇ Channel Auto Switch (CH Auto SW)

Select whether or not to automatically switch to Channel 16 or the specified channel; or select whether to switch or ignore DSC call.

- **Accept:** After receiving a DSC call, the transceiver remains on the operating channel for 10 seconds. After that, the transceiver automatically switches to the channel that is specified on the DSC call.
- **Ignore:** After receiving a DSC call, if you do not press the softkey [ACPT] in 10 seconds, the transceiver ignores the call, and then remains on the current operating channel.
- **Manual:** After receiving a DSC call, you can select whether or not to accept the received DSC call.

◇ Data Output

When receiving a DSC call from the station that is selected in this setting, the transceiver outputs the DSC data to the NMEA output port.

NOTE: You can send Distress calls despite of this setting.

- **All Stations:** From any station.
- **Station List:** From the stations that are entered Individual ID or Group ID on the Menu screen.
- **OFF:** Does not output any DSC data from the NMEA 0183 Output port.

◇ Alarm Status

Set the alarm ON or OFF for each DSC related item. The factory default setting for each type is: ON.

- **Safety:** An alarm sounds when a Safety DSC call is received.
- **Routine:** An alarm sounds when a Routine DSC call is received.

• Warning:

- * No MMSI code is entered.
- * The position data has not been received for 2 minutes after turning ON the transceiver.
- * The received position data has not been updated for 10 minutes.
- * The received position data has not been updated for 4 hours.
- * The manually entered position data has not been updated for 23.5 hours.

• **Self-Terminate:** An alarm sounds when duplicate DSC calls are received.

• **Discrete:** An alarm sounds when a lower priority call is received while receiving a high priority call.

◇ CH 70 SQL Level

Adjust the Squelch level for Channel 70 to between 1 and 10, or open.

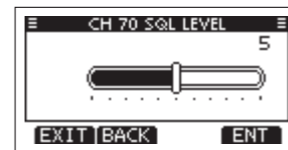

◇ Self-Test

The Self-Test sends DSC signals to the receiving AF circuit to compare the sending and receiving signals at the AF level.

1. Display the "SELF-TEST" screen.
2. Press softkey [ENT] or [OK] key to start the Self-Test.
 - When the transmitting and receiving DSC signals match, "OK" is displayed.

- If "NG" is displayed, that means there is a problem with at least one of the transmitting DSC and the receiving DSC circuit. The transceiver must be handed over to the dealer for repair.

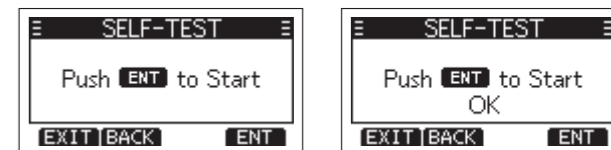

◇ Multi-Task

You can select the type of task for the transceiver, depending on the presetting.

- **Single:** Handles only 1 task at the same time.
- **Multiple:** Handles up to 7 tasks at the same time.

■ Distress Call

A Distress call should be sent if the ship or a person is in distress and requires immediate assistance.

NEVER make a Distress call if your ship or a person is not in an emergency. A Distress call should be made only when immediate help is needed.

◇ Distress Call Softkey Description

While waiting for an Acknowledgement:

1. [CANCEL]: Cancels the Distress call and enables you to send a Cancel call.
2. [RESEND]: Enables you to resend the Distress call by

- holding down [DISTRESS] again.
- [PAUSE]: Pauses the countdown to resend the next Distress call.
 - [INFO]: Displays the information of the Distress call that you have sent.

After receiving an Acknowledgement:

- [STBY]: Closes the Distress operation, and returns to the operating screen.
- [HIST]: Displays the "DISTRESS HISTORY".
- [INFO]: Display the information of the received Distress Acknowledgement.

◇ Simple Call

- Confirm that no Distress call is being received.
- While lifting up the key cover, hold down [DISTRESS] for 3 seconds until you hear 3 short countdown beeps and a long beep sound.
 - The backlight blinks.

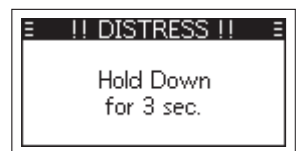
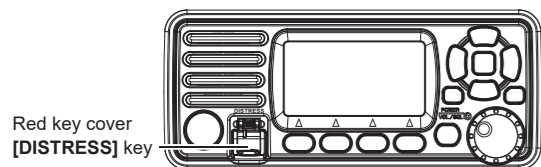

NOTE: When the transceiver does not receive any valid location data, the stored location data will be used for distress calls.

- After sending, wait for an Acknowledgement call, "Waiting for ACK" is displayed.
 - The Distress call is automatically sent every 3.5~4.5 minutes, until an Acknowledgement is received, or a Distress Cancel call is sent.
 - Press softkey [RESEND] to manually resend the Distress call.
 - Press [◀] [▶], then press softkey [INFO] to display the information of the Distress call that you have sent.
 - Press [◀] [▶], then press softkey [PAUSE] to pause the countdown to resend the next Distress call, press [RESUME COUNTDOWN] to resume the countdown.

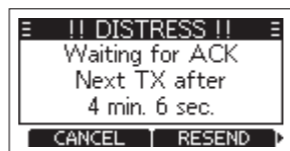

- When you receive an Acknowledgement, an alarm sounds, press [ALARM OFF] to turn OFF the alarm.
- Hold down [PTT], and then talk to explain your situation.
- After you have finished your conversation, then press [CANCEL] to return to the operating screen.

A default Distress alert contains:

- Nature of Distress: Undesignated distress.
- Position Information: The latest GPS, or manually input position, which is held for 23.5 hours, or until turning OFF the transceiver.

◇ Regular Call

Select the nature of the Distress call to include in the Regular Distress call.

- Press softkey [DIST CALL] or [DTRS], the "DISTRESS" screen is displayed.
- Press [OK] or softkey [ENT] to enter the Nature selection mode.
- Press [▲] [▼] or rotate [DIAL] knob to select the nature of the Distress, then press [OK] or softkey [ENT].
 - If no valid GPS data is being received, press [▲] [▼] or rotate [DIAL] knob to select "Position", then enter the latitude, longitude and UTC.
 - The nature of distress includes Undesignated, Fire, Explosion, Flooding, Collision, Grounding, Capsizing, Sinking, Adrift, Abandoning Ship, Piracy, Man Overboard.

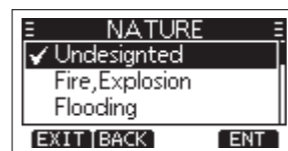

- While lifting up the key cover, hold down [DISTRESS] for 3 seconds until you hear 3 short countdown beeps and a long beep sound.
 - The backlight blinks.

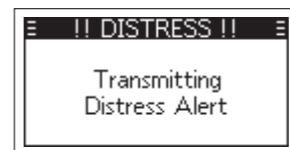
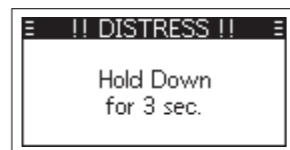

- After sending, wait for an Acknowledgement call, "Waiting for ACK" is displayed.
 - The Distress call is automatically sent every 3.5~4.5 minutes, until an Acknowledgement is received, or a Distress Cancel call is sent.
 - Press softkey [RESEND] to manually resend the Distress call.
 - Press [◀] [▶], then press softkey [INFO] to display the information of the Distress call that you have sent.
 - Press [◀] [▶], then press softkey [PAUSE] to pause the countdown to resend the next Distress call, press [RESUME COUNTDOWN] to resume the countdown.

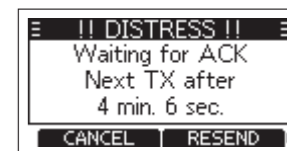

- When you receive an Acknowledgement, an alarm sounds, press [ALARM OFF] to turn OFF the alarm, then hold down [PTT] to communicate.

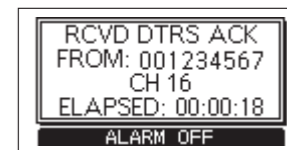

A default Distress alert contains:

- Nature of Distress: Select as per Step 2.
- Position Information: The latest GPS, or manually input po-

sition, which is held for 23.5 hours, or until turning OFF the transceiver.

◇ Distress Cancel Call

If you have accidentally made a Distress call, or made an incorrect Distress call, send a Distress Cancel call to cancel the call as soon as possible while waiting for an Acknowledgement call, be sure to report the purpose of the cancellation.

1. While waiting for an Acknowledgement call, press softkey [**CANCEL**].

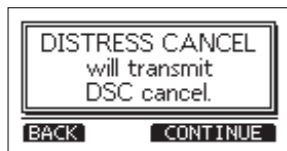

2. Press softkey [**CONTINUE**], to send Distress Cancel call.
3. Channel 16 is automatically selected.
4. Hold down [**PTT**] to report the purpose of the cancellation.
 - You can display the wording of the cancellation by press [**▼**].

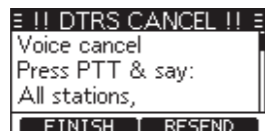
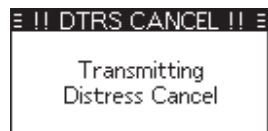

5. After communicating, press softkey [**FINISH**].

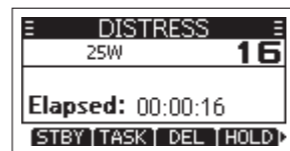

6. Press softkey [**STBY**] to finish the Distress Cancel call, returns to the operating screen.

◇ Receiving DSC Calls (Distress)

The transceiver receives Distress calls, Distress Acknowledgement calls and Distress Cancel calls. The following steps are described using an example of receiving a Distress call.

When a Distress call is received:

- The emergency alarm sounds until you turn it OFF.
- “RCVD DISTRESS” is displayed, screen backlight blinks.

1. Press softkey [**ALARM OFF**] to turn OFF the alarm and screen backlight blinks.



2. Press the softkey below the intended operation.



- ⇒ **Ignore [IGN]**
 - Ignore the call and return to the operating screen.
 - The call is saved in the DSC Log.
 - “” blinks continuously until you display the call message.
- ⇒ **Pause [PAUSE]**
 - [**PAUSE**] is not displayed if the “CH Auto SW” item is set to “Manual”.
 - Pause the countdown until the assigned channel is automatically selected.
 - Select softkey [**RESUME**] to resume the countdown.
 - The call is saved in the DSC Log.
- ⇒ **Accept [ACPT]**
 - Accept the call.
 - Channel 16 is automatically selected.
 - Monitor Channel 16 as a coast station may require assistance.
 - After Channel 16 is selected, you can select your next operation by pressing the softkey below the following options.
- ⇒ **Return [EXIT]**
 - Returns to the operating screen.
- ⇒ **History [HIST]**
 - Displays the “DISTRESS HISTORY” screen.
- ⇒ **Information [INFO]**
 - Displays the information of the received Distress call.

■ Individual Call

An Individual call enables you to send a DSC signal to only a specific station.

◇ Sending an Individual Call

1. Press softkey [**DSC CALL**], the “OTHER DSC” screen is displayed.

NOTE: You can also display the “OTHER DSC” screen by selecting the “DSC Call” item on the Menu screen.

2. Select “Type”, then press [**OK**].
3. Select “Individual”, then press [**OK**] or softkey [**ENT**].
 - Returns to the “OTHER DSC” screen.
4. Select “Address”, then press [**OK**] or softkey [**ENT**].
5. Select the station to send an Individual call to , then press [**OK**] or softkey [**ENT**].
 - Returns to the “OTHER DSC” screen.

NOTE: You can also select “Manual Input” to manually enter the target station.

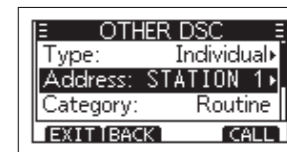

6. Select “Channel”, then press [**OK**] or softkey [**ENT**].
7. Select a channel to assign, and then press [**OK**] or softkey [**ENT**].

- The assigned channels are preset by default.



- Press softkey [**CALL**] to send the Individual call.
 - “Transmitting Individual Call” is displayed, and then “Waiting for ACK” is displayed.

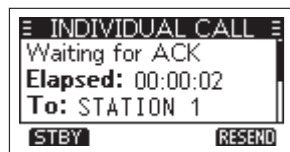
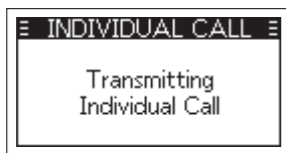
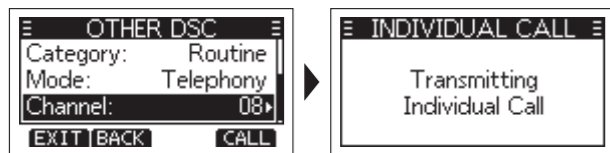

- When you receive an Acknowledgement “Able to comply”, an alarm sounds, the screen as below is displayed.



Press softkey [**ALARM OFF**] to turn OFF the alarm, the channel assigned in above step is automatically selected.

- If the called station cannot use the channel that you assigned, a different channel is selected by the station.
- Hold down [**PTT**] to communicate.

When you receive an Acknowledgement “Unable to comply”, an alarm sounds, the Acknowledge information is displayed. Press [**STBY**], then press [**OK**] to return to the operating screen.

- After communication, press softkey [**EXIT**] to return to the operating screen.

◇ Sending an Individual Acknowledgement

When you have received an Individual call, send an Acknowledgement to the calling station, select “Able to Comply”, “Propose New CH” or “Unable to Comply”.

- While an Individual call is being received, an alarm sounds, the screen as below is displayed. Press softkey [**ALARM OFF**] to turn OFF the alarm.



- Press softkey [**ACPT**], the Acknowledgement category screen is displayed.
 - If you want to send an Acknowledgement “Able to Comply” right away, press softkey [**ABLE**].
 - If you cannot communicate, and want to return to the oper-

ating screen, press [**IGN**].

- Press softkey [**ABLE**] | [**UNABLE**] | [**NEWCH**] to select the Acknowledgement type.

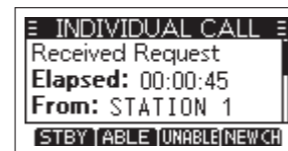

- **ABLE (Able to Comply)**: Sends an Acknowledgement call without any changes.
- **UNABLE (Unable to Comply)**: Sends an Acknowledgement call but cannot communicate.
- **NEWCH (Propose New CH)**: Ables to communicate but proposes another channel. Specify the channel by press [**▲**] or [**▼**] (Example: Channel 68).



- Press softkey [**CALL**] to send the Acknowledgement call.

◇ Receiving an Individual Call

When an Individual call is received:

- The alarm sounds.
- “RCVD INDIVIDUAL” is displayed.

- Press softkey [**ALARM OFF**] to turn OFF the

alarm.



- Press the softkey for the next operation.



- ⇒ Press [**IGN**]: Ingores the call and returns to the operating screen.
 - “” blinks continuously until you display the call message.
 - The call is saved in the DSC Log.
- ⇒ Press [**ABLE**]: Able to comply, sends an Individual Acknowledgement call right away.
 - The assigned channel is automatically selected.
 - After sending, press [**RESEND**] to resend.
 - The call is saved in the DSC Log.
- ⇒ Press [**ACPT**]: Accepts the call.
 - The assigned channel is automatically selected.
 - The call is saved in the DSC Log.
 - The received call’s information is displayed.
 - Press the softkey to select the Acknowledgement option.

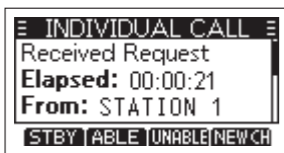

ABLE (Able to Comply): Sends an Acknowledgement call without any changes.

UNABLE (Unable to Comply): Sends an Acknowledgement call but cannot communicate.

NEWCH (Propose New CH): Able to communicate but proposes another channel. Specify the channel by press [▲] or [▼].

NOTE: If the Auto ACK function is set to "Auto (Unable)", the Acknowledgement "Unable to Comply" is automatically sent to the calling station when the call is received. This function is set to "Auto (Able)" by default.

■ Group Call

A Group call enables you to send a DSC call to only a specific group. A group of fleets corresponds to a group call identification code, and the entire fleet will be called when the group calls.

◇ Sending an Group Call

You can send a Group call to a pre-entered group address, or manually enter the address before sending.

1. Press softkey [**DSC CALL**], the "OTHER DSC" screen is displayed.

NOTE: You can also display the "OTHER DSC" screen by selecting the "DSC Call" item on the Menu screen.

2. Select "Type", then press [OK], "MESSAGE TYPE" is displayed.
3. Select "Group", then press [OK] or softkey [**ENT**].
 - Returns to the "OTHER DSC" screen.



4. Select "Address", then press [OK].
5. Select the group to send an Group call to, then press [OK].

NOTE: You can also select "Manual Input" to manually enter the target group.

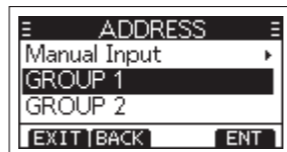

6. Select "Channel", then press [OK].
7. Select a channel to assign, and then press [OK] or softkey [**ENT**].
 - The assigned channels are preset by default.



8. Press softkey [**CALL**] to send the Group call.
 - "Transmitting Group Call" is displayed, and then the assigned channel is automatically selected.

NOTE: If Channel 70 is busy, the transceiver stands by until the channel becomes clear.

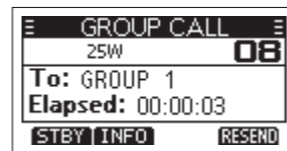
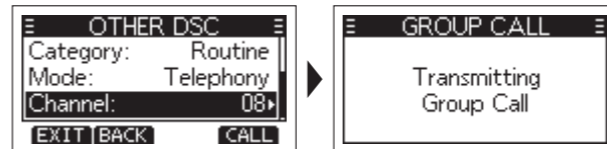

9. Hold down [PTT] to communicate.

◇ Receiving an Group Call

When a Group call is received:

- The alarm sounds for 2 minutes.
- "RCVD GROUP CALL" is displayed.

1. Press softkey [**ALARM OFF**] to turn OFF the alarm.
 - The channel that is assigned by the caller is automatically selected after 10 seconds by default.
2. Press the softkey for the next operation.

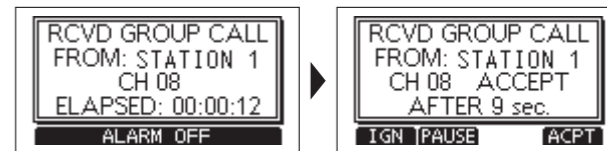

- ⇒ Press [**IGN**]: Ignores the call and returns to the operating screen.
 - "☐" blinks continuously until you display the call message.
 - The call is saved in the DSC Log.
- ⇒ Press [**PAUSE**]: Pauses the countdown until the assigned channel is automatically selected.

NOTE: [**PAUSE**] is not displayed if the "CH Auto SW" item is set to "Manual".

- Select [**RESUME**] to resume the countdown.
- The call is saved in the DSC Log.
- ⇒ Press [**ACPT**]: Accepts the call.
 - The assigned channel is automatically selected.
 - The call is saved in the DSC Log.
- ⇒ Press [**STBY**]: Closes the Group call, then returns to the operating screen.
- ⇒ Press [**INFO**]: The receiver call's information is displayed.

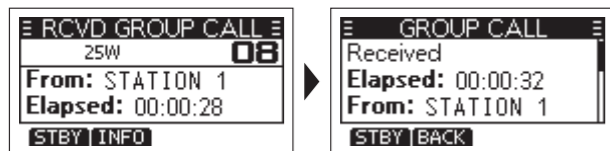

■ All Ships Call

An All Ships call enables you to announce a message to all the ships within range.

◇ Sending an All Ships Call

1. Press softkey [**DSC CALL**], the "OTHER DSC" screen is displayed.

NOTE: You can also display the "OTHER DSC" screen by selecting the "DSC Call" item on the Menu screen.

2. Select "Type", then press [**OK**], "MESSAGE TYPE" is displayed.
3. Select "All Ships", then press [**OK**] or softkey [**ENT**].
 - Returns to the "OTHER DSC" screen.

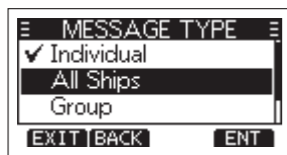

4. Select "Category", then press [**OK**].
5. Select a category of the call, then press [**OK**] or softkey

6. Select "Channel", then press [**OK**].
7. Select a channel to assign, and then press [**OK**] or softkey [**ENT**].
 - The assigned channels are preset by default.

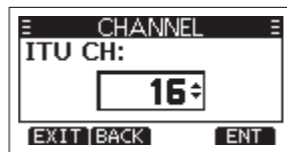

8. Press softkey [**CALL**] to send the All Ships call, "Transmitting All Ships Call" is displayed, and then the assigned channel is automatically selected.

NOTE: If Channel 70 is busy, the transceiver stands by until the channel becomes clear.



9. Hold down [**PTT**] to communicate.

◇ Receiving an All Ships Call

When an All Ships call is received:

- The alarm sounds
- "RCVD ALL SHIPS CALL" is displayed.

1. Press softkey [**ALARM OFF**] to turn OFF the alarm.
 - The channel that is assigned by the caller is automatically selected after 10 seconds by default.
2. Press the softkey for the next operation.

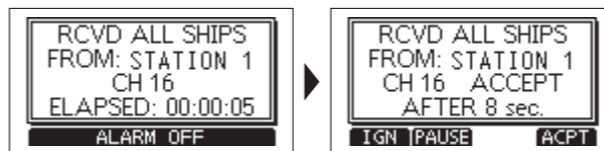

- ⇒ Press [**IGN**]: Ignores the call and returns to the operating screen.
 - The call is saved in the DSC Log.
 - " " blinks continuously until you display the call message.
- ⇒ Press [**PAUSE**]: Pauses the countdown until the assigned channel is automatically selected.

NOTE: [**PAUSE**] is not displayed if the "CH Auto SW" item is set to "Manual".

- ⇒ Press [**ACPT**]: Accepts the call.
 - The assigned channel is automatically selected.
 - The call is saved in the DSC Log.

- ⇒ Press [**STBY**]: Closes the All Ships call, then returns to the operating screen.
- ⇒ Press [**INFO**]: The receiver call's information is displayed.

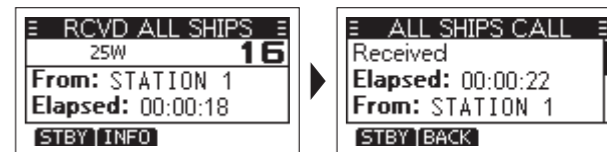

■ Position Request Call / Polling Request Call

When you want to know information about the current location of a ship, you can send a Position Request call.

◇ Sending a Position Request Call/ Polling Request Call

1. Press softkey [**DSC CALL**], the "OTHER DSC" screen is displayed.

NOTE: You can also display the "OTHER DSC" screen by selecting the "DSC Call" item on the Menu screen.

2. Select "Type", then press [**OK**], "MESSAGE TYPE" is displayed.
3. Select "Position", then press [**OK**] or softkey [**ENT**].
 - The message type is selected, and returns to the "OTHER DSC" screen.

NOTE: When you send a Polling Request call, select "Polling".



4. Select "Address", and then press [OK].
5. Select a target to send a Position Request call to, and then press [OK] or softkey [ENT].

NOTE: You can also select "Manual Input" to manually enter the target ID.

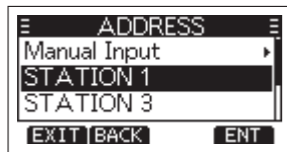

6. Press softkey [CALL] to send the Position Request call.
 - "Transmitting Position Request" is displayed, and then the assigned channel is automatically selected.

NOTE: If Channel 70 is busy, the transceiver stands by until the channel becomes clear.

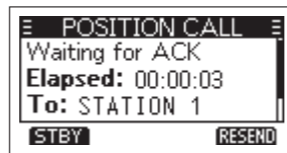
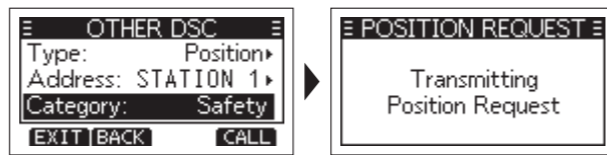

7. When you receive a Position Reply:
 - An alarm sounds.



8. Press softkey [ALARM OFF] to turn OFF the alarm.
9. Press softkey [CLOSE], the received information is displayed.
10. Press [▲]/[▼] to scroll the screen then check the target's position.
11. Press softkey [STBY], and then press [OK] to return to the operating screen.

◇ Receiving a Position Request Call/Polling Request Call

When an Position Request call is received:

- The alarm sounds for 2 minutes.
- "RCVD POS REQUEST" is displayed.

1. Press softkey [ALARM OFF] to turn OFF the alarm.
2. Press the softkey for the next operation.



- ⇒ Press [IGN]: Ignores the call and returns to the operating screen.
 - The call is saved in the DSC Log.
 - " " blinks continuously until you display the call message.
- ⇒ Press [ABLE]: Sends the Acknowledgement "Able to Comply".
 - The call is saved in the DSC Log.
- ⇒ Press [UNABLE]: Sends the Acknowledgement "Unable to Comply".
 - Displays the Acknowledgement information, and then press [EXIT] to return to the operating screen.
 - The call is saved in the DSC Log.
- ⇒ Press [ACPT]: Accepts the call.
 - The received call's information is displayed.

- The call is saved in the DSC Log.
- Press [ABLE] or [UNABLE], then press [CALL] to send the Position Reply call.



NOTE:

- If the Auto ACK function in "DSC Settings" is set to "Auto", the Position Reply is automatically sent to the calling station.
- However, even if the Auto ACK function is set to "Manual", after receiving a Distress Acknowledgement, or while in the Distress Cancel call procedure, the Position Reply is automatically sent to the calling station.

◇ Sending a Position Reply Call

Send a Position Reply call when a Position Request call is received. If the Auto ACK function in "DSC Settings" is set to "Auto", the Acknowledgement is automatically sent to the calling station.

1. While a Position Request call is being received, press softkey [ALARM OFF] to turn OFF the alarm.



- Press softkey [**ACPT**], the received call's information is displayed.



- Press softkey [**ABLE**] to send an "Able to Comply" Acknowledgement, or press softkey [**UNABLE**] to send an "Unable to Comply" Acknowledgement.

NOTE: If no valid GPS position is received, you can manually enter the position and time in "Position" item on this screen. See "Entering the position and time" for details.



- Press softkey [**CALL**] to send the Position Reply call.

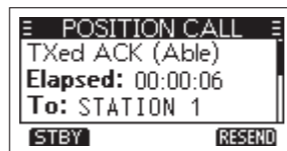
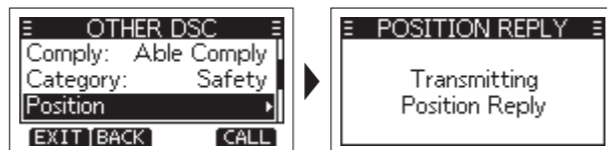

- Press softkey [**STBY**], and then press [**OK**] to return to the operating screen.

■ Test Call

You should avoid testing calls on the specific DSC distress channels and safety calling channels. When you cannot avoid testing on a distress or safety channel, you should indicate that these are test calls. Normally the test call would require no further communications between the two stations involved.

◇ Sending a Test Call

- Press softkey [**DSC CALL**], the "OTHER DSC" screen is displayed.

NOTE: You can also display the "OTHER DSC" screen by selecting the "DSC Call" item on the Menu screen.

- Select "Type", then press [**OK**], "MESSAGE TYPE" is displayed. Select "Test", then press [**OK**] or softkey [**ENT**].

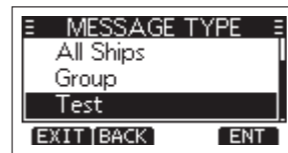

- Select "Address", and then press [**OK**].

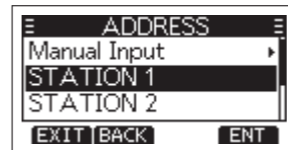

- Select a station to send the Test call to.

NOTE: You can also select "Manual Input" to manually enter the calling station.

- Press softkey [**CALL**] to send the Test call, "Transmitting Test Call" is displayed.

NOTE: If Channel 70 is busy, the transceiver stands by until the channel becomes clear.

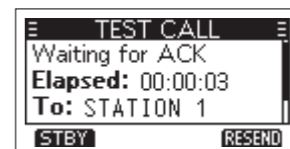

- When you receive an Acknowledgement:
 - An alarm sounds, the screen is displayed as below.



- Press softkey [**ALARM OFF**] to turn OFF the alarm.
- Press softkey [**STBY**], "Terminate the procedure. Are you sure?" is displayed.
- Press softkey [**OK**] to return to the operating screen.

◇ Receiving a Test Call

By default, the Auto ACK function automatically sends an Acknowledgement to the calling station. If the function is set to "Manual", the following screens are displayed.

When a Test call is received:

- The alarm sounds for 2 minutes.
- "RCVD TEST CALL" is displayed.

1. Press softkey [**ALARM OFF**] to turn OFF the alarm.
2. Press the softkey for the next operation.

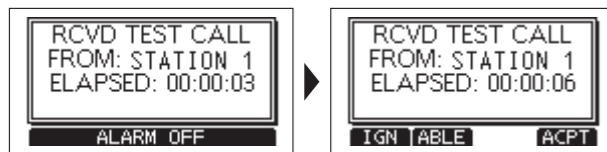

- ⇒ Press [**IGN**]: Ignores the call and returns to the operating screen.
 - The call is saved in the DSC Log.
 - " " blinks continuously until you display the call message.
- ⇒ Press [**ABLE**]: Sends the Acknowledgement "Able to Comply".
 - The call is saved in the DSC Log.
- ⇒ Press [**ACPT**]: Accepts the call.
 - The received call's information is displayed.
 - The call is saved in the DSC Log.
 - Press softkey [**ACK**], then press [**CALL**] to send a Test Acknowledgement call.
 - Press softkey [**RESEND**] to resend.

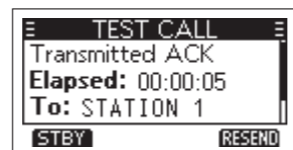
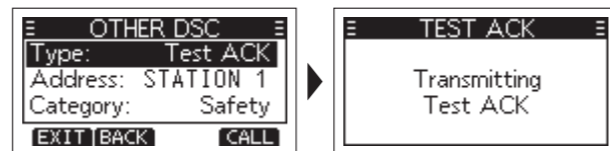

NOTE: If the Auto ACK function in "DSC Settings" is set to "Auto", the Test Acknowledgement call is automatically sent to the calling station when the call is received.

◇ Sending a Test Acknowledgement Call

By default, when you receive a Test call, the Auto ACK function automatically sends an Acknowledgement to the calling station. If the function is set to "Manual", do the following steps to send an Acknowledgement.

1. After a Test call is being received, press [**ALARM OFF**] to turn OFF the alarm.
2. Press softkey [**ACPT**], the received call's information is displayed.
3. Press softkey [**ACK**], the "Test ACK" confirmation screen is displayed.

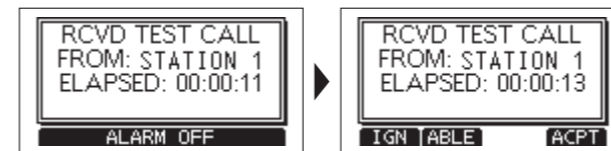

4. Press softkey [**CALL**] to send the Acknowledgement, "Transmitting Test Ack" is displayed.

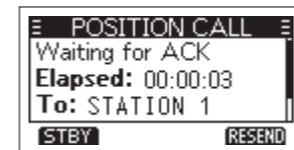
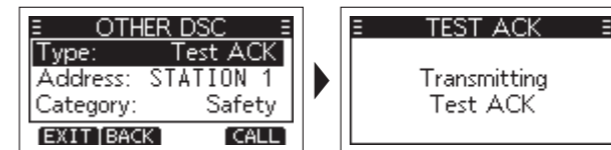

5. Press softkey [**STBY**], a confirmation screen is displayed.

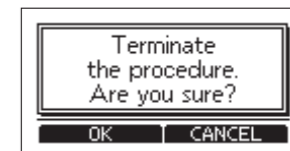

6. Press [**OK**] to return to the operating screen.

◇ Receiving a Test Acknowledgement Call

After sending a Test call, the called station will send you a Test Acknowledgement call.

When a Test Acknowledgement call is received:

- The alarm sounds for 2 minutes.
- "RCVD TEST ACK" is displayed.



1. Press softkey [**ALARM OFF**] to turn OFF the alarm.
2. Press softkey [**CLOSE**], the received call's information is displayed.
 - The call is saved in the DSC Log.



- Press [**STBY**] to return to the operating screen.

■ DSC Log

◇ Received DSC Log

The transceiver saves up to 30 received Distress call messages and 50 received “Other” call messages in your DSC Log. On the operating screen, “**✉**” is displayed when there is an unread call message; “**✉**” blinks when there is a new received call message.

- Press softkey [**LOG**] to display the “RCVD CALL LOG” screen.

NOTE: You can also enter “RCVD CALL LOG” screen by menu operation, steps as below:

Menu → **DSC Log** → **Received Call Log**

- Press [**▲**]/[**▼**] to select “Distress” or “Others”, then press [**OK**] or softkey [**ENT**].

NOTE:

- **Distress:** Displays the received Distress call log.
- **Others:** Displays the received DSC call log.

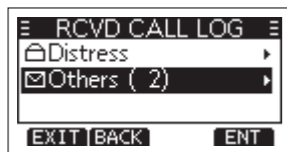

- Press [**▲**]/[**▼**] to scroll through the log.

- Press softkey [**ENT**] to display the received call's information.

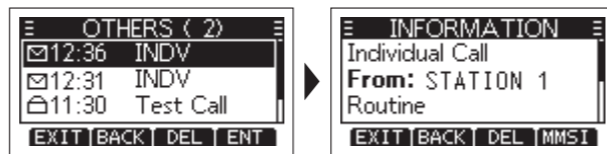

- ⇒ Press [**EXIT**]: Returns to the operating screen.
- ⇒ Press [**BACK**]: Returns to the previous screen.
- ⇒ Press [**DEL**]: Deletes the selected call log.

NOTE: The confirmation screen is displayed before deleting.

- ⇒ Press [**MMSI**]: Saves the MMSI as an Individual ID.

◇ Transmitted DSC Log

The transceiver saves up to 30 DSC transmitted calls in your DSC Log.

- Press [**MENU**], then press [**▲**]/[**▼**] to select “DSC Log”, and then press [**OK**].
- Press [**▲**]/[**▼**] to select “Transmitted Call Log”, then press [**OK**] or softkey [**ENT**].
 - The “TX CALL LOG” screen is displayed.
- Press [**▲**]/[**▼**] to scroll through the log.
- Press softkey [**ENT**] to display the sent call's information.

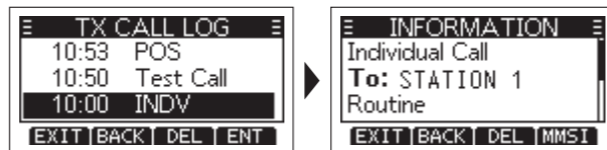

- ⇒ Press [**EXIT**]: Returns to the operating screen.
- ⇒ Press [**BACK**]: Returns to the previous screen.
- ⇒ Press [**DEL**]: Deletes the selected call log.

NOTE: The confirmation screen is displayed before deleting.

- ⇒ Press [**MMSI**]: Saves the MMSI as an Individual ID or a Group ID.

■ Multiple-task Mode

If the Multiple-task function is enabled, the transceiver can hold up to 7 tasks. Therefore, you can handle more than 2 DSC tasks simultaneously by switching between the DSC tasks.

◇ Setting Multiple-task Mode

- You can enter “MULTI-TASK” screen by menu operation, steps as below:
Menu → **DSC Settings** → **Multi-Task**
- Press [**▲**]/[**▼**] to select required multi-task mode, then press [**OK**] or softkey [**ENT**].

NOTE:

- **Single:** Single task mode, you can handle one DSC task.
- **Multiple:** Multi-task mode, you can handle more than 2 DSC tasks.

- When the Multiple-task mode is activated, [**TASK**] is displayed on the operating screen.

NOTE: The Task mode has a Time-out Timer (TOT) function. After a certain period of time has passed without any operation on a task, the transceiver automatically exits the Task

mode and returns to the operating screen. When a Time-out Timer (TOT) activates, an alarm sounds and a countdown message is displayed for 10 seconds.

◇ Holding a DSC Task

In the Multiple-task mode, you can hold or activate the DSC task, operations as follows.

Example: When a Group call is received,

- Press softkey [**ALARM OFF**] to turn OFF the alarm.
 - The received call's information is displayed.
- Press softkey [**HOLD**].
 - The received Group call task is held into the task list and returns to the operating screen.

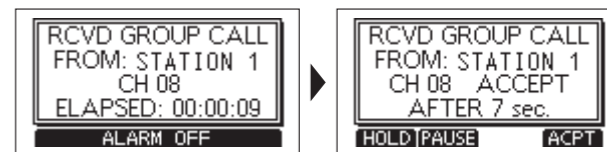

◇ Activating the Held DSC Task

- Press softkey [**TASK**] to display the task list.
- Press [**▲**]/[**▼**] to select the task that you want to activate.

- Press softkey [**ACTIVE**] to activate the task.
 - The activated task information is displayed.

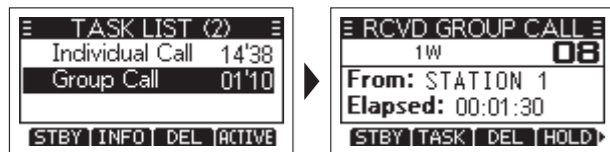

- Press [PTT] to communicate.
- After finishing the communication, press softkey [**DEL**] to delete the task.

◇ Task List

When one or more tasks are held, you can display the task list screen by pressing softkey [**TASK**], the number of tasks is displayed at the top of the screen.

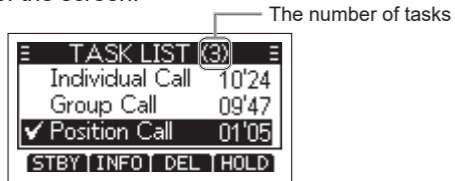

On the “TASK LIST” screen, the following softkeys are displayed.

- ⇒ Press [**STBY**]: Holds the task and returns to the operating screen.
- ⇒ Press [**INFO**]: Displays the task information.
- ⇒ Press [**DEL**]: Deletes the selected task.
- ⇒ Press [**HOLD**]: Holds the selected task.
- ⇒ Press [**ACTIVE**]: Activates the selected task.

MENU SCREEN OPERATION

■ Menu Screen Operation

The Menu screen is used to set items, select options, and so on for the transceiver's functions.



◇ Entering Menu Screen Operation

- Press [**MENU**], the Menu screen is displayed.
- Press [**▲**]/[**▼**] to select the required menu item, then press [**OK**] to confirm, or to enter next level menu.
 - Repeat this operation to enter all levels of menu items.
- Press [**BACK**] or softkey [**BACK**] to return to the previous screen.
- Press softkey [**EXIT**] to exit the Menu screen.

■ Menu Screen Items

The Menu screen contains the following items.

Main Menu Item	Submenu Item	Display	Ref.
Distress	Nature of Distress	Nature	25
	Position	Position	19
DSC Call	Type	Type	27
	Address	Address	27
	Category	Category	27
	Mode	Mode	27
GPS Info (Display Position Info)	Channel	Channel	27
	Source	Source	-
	Latitude	LAT	
	Longitude	LON	
	UTC Time	UTC	
	Speed	SOG	
Configuration	Course	COG	
	Backlight	Backlight	
	Display Contrast	Display Contrast	47

Main Menu Item	Submenu Item	Display	Ref.
Configuration	Key Beep	Key Beep	47
	Key Assignment	Key Assignment	47
	UTC Offset	UTC Offset	47
	Inactivity Timer	Inactivity Timer	47
	GPS Configuration	GPS	47
DSC Log	Received Call Log	Received Call Log	40
	Transmitted Call Log	Transmitted Call Log	40
Radio Settings	Scan Type	Scan Type	45
	Scan Timer	Scan Timer	45
	Dual/Tri-watch	Dual/Tri-Watch	45
	Channel Group	Channel Group	45
	Call Channel	Call Channel	45
	Weather Alert	WX Alert	45
	Favorite Channel Settings	FAV Settings	45
	Favorite Channel Selection	FAV on MIC	46
	Channel Display Digit	CH Display	46
	Channel Close-up	CH Close-up	46

Main Menu Item	Submenu Item	Display	Ref.
DSC Settings	Position Input	Position Input	19
	Individual ID	Individual ID	20
	Group ID	Group ID	21
	Auto Acknowledgement	Auto ACK	22
	Channel Auto Switch	CH Auto SW	22
	Data Output	Data Output	22
	Alarm Status	Alarm Status	22
	Channel 70 Squelch Level	CH 70 SQL Level	23
	Self-Test	Self-Test	23
	Multi-Task	Multi-Task	23
ATIS Settings	ATIS ON/OFF	ATIS ON/OFF	19
	ATIS ID Input	ATIS ID Input	19
Radio Info (Inquiry MMSI, ATIS and Ver. Info)	MMSI Code	MMSI	-
	ATIS Code	ATIS (Displays only when ATIS function is activated)	-
	GPS Version	GPS Ver	-
	Firmware Version	Firm Ver	-
	Hardware Version	Hard Ver	-

■ Radio Settings

No.	Setting Items	Setting Options	Defaults
1	SCAN TYPE	Normal Scan Priority Scan	Normal Scan
2	SCAN TIMER	ON/OFF	OFF
3	DUAL/TRI-WATCH	Dualwatch Tri-watch	Dualwatch
4	CHANNEL GROUP	USA/ INT/ CAN	USA
5	CALL CHANNEL	Channel 00~P3	Channel 09
6	WX ALERT	ON with Scan/ ON/ OFF	OFF
7	FAV SETTINGS	Set All Channels/ Clear All Channels/ Set Default	-----
8	FAV ON MIC	ON/ OFF	OFF
9	CH DISPLAY	3 Digits/ 4 Digits	3 Digits
10	CH CLOSE-UP	ON/ OFF	OFF

◇ Scan Type

The transceiver has 2 scan types: Normal Scan and Priority Scan.

- **Normal Scan:** Scans all Favorite channels in the selected channel group.
- **Priority Scan:** Sequentially scans all Favorite channels while monitoring Channel 16.

◇ Scan Timer

Scan Timer can be set as OFF or ON.

While set as OFF, when a signal is detected on a channel, the scan pauses until the signal disappears, and then resumes.

While set as ON, when a signal is detected on a channel, the scan pauses for 5 seconds, and then resumes. If the signal disappears in less than 5 seconds, the scan immediately resumes.

◇ Dualwatch/Tri-watch

Select Dualwatch or Tri-watch, see corresponding chapter for details.

◇ Channel Group

Select the suitable channel group for your operating area, including USA, INT, CAN Channel Group.

◇ Call Channel

You can change your Call channel.

◇ WX Alert

When there is any important weather information, an NOAA broadcast station transmits a Weather Alert tone. While WX Alert function is ON, “WX☁” is displayed instead of “WX”. When detecting an alert, an alarm sounds and “WX☁” blinks.

- **ON with Scan:** The preset Weather channels are sequentially checked while scanning.
- **ON:** The previously selected (last used) Weather channel is checked while scanning.
- **OFF:** The Weather Alert tone is not detected.

◇ FAV Settings

You can set all channels as Favorite channels, clear all settings, or reset to default. By default, some channels are preset.

- **Set All Channels:** Sets all channels as Favorite channels.
- **Clear All Channels:** Clears all Favorite channels.
- **Set Default:** Resets Favorite channels to the default.

◇ FAV on MIC

You can select the channel set when you press [▲]/[▼] on the supplied microphone.

◇ CH Display

You can select the number of digits to display the channel number, 3 Digits or 4 Digits.

◇ CH Close-up

You can select whether or not to display the channel name when changing the operating channel. While the function is ON, when you press [▲]/[▼] to select channels, the selected channel number and name will display for 1 second, then return to normal screen.

■ Configuration

Items	Options	Defaults	
BACKLIGHT	7 Levels/ OFF	Level 4	
DISPLAY CONTRAST	Level 1~8	Level 3	
KEY BEEP	ON/ OFF	ON	
KEY ASSIGNMENT	Softkey 1~16	SCAN, DW/TW, CH/WX, H/L, ATT, VIB, TAG, NAME, BL, LOG	
UTC OFFSET	-14:00~+14:00	00:00	
INACTIVITY TIMER	Not DSC	Off, 1-15 min	10 min
	DSC	Off, 1-15 min	15 min
	Distress	Off, 1-15 min	OFF
GPS	RT	10/30 sec, 1~10 min	30 sec
	GPS	ON	ON
	GLONASS	ON/ OFF	ON
	SBAS	ON/ OFF	OFF

◇ Backlight

You can adjust the backlight brightness between 1 and 7, or OFF. When backlight function is ON, press any key (except for [PTT]), the backlight ON.

◇ Display Contrast

You can adjust the display contrast level between 1 (lowest) and 8 (highest).

◇ Key Beep

You can select whether or not to sound a beep when a key is pressed.

◇ Key Assignment

You can change which softkey functions to display, and their order.

1. Display the "KEY ASSIGNMENT" screen, press [▲]/[▼] to select the softkey you want to set up, then press [OK] to enter.
2. Press [▲]/[▼] to select the function you want to set up, then press [OK] to confirm setting.

◇ UTC Offset

You can set the offset time between UTC (Universal Time Coordinated) and your local time to between -14:00 and +14:00, in a minute steps.

◇ Inactivity Timer

The transceiver automatically returns to the operation screen if you press no key for the set period of time for each mode.

- ⇒ **Not DSC** (Default: 10 min)
Setting for when a screen that is not related to DSC is displayed.
- ⇒ **DSC** (Default: 15 min)
Setting for when a screen that is related to DSC is displayed.
- ⇒ **Distress** (Default: Off)
Setting for when a screen that is related to a Distress call is displayed.

⇒ **RT** (Default: 30 sec)

Setting for when the transceiver is in the Radio Telephone mode.

◇ GPS

Selects a satellite to be used for GPS (Global Positioning System) to pinpoint the geographic location of your transceiver anywhere in the world.

NOTE: This setting cannot be used if the transceiver does not have an optional GPS function module.

- **GPS:** The GPS is permanently set to ON.
- **GLONASS:** Select whether or not to use the data from the GLONASS (GLObal'naya Navigatsionnaya Sputnikovaya Sistema) satellites.
- **SBAS:** Turns the SBAS (Satellite Based Augmentation System) function ON or OFF. The SBAS transmits signals to correct errors, and improves accuracy and reliability in data received from regular GNSS satellites. When this function is ON, you can use the corrected data.

■ VHF MARINE RADIO CHANNEL LIST (Default USA)

Channel Number		Frequency (MHz)		Channel Number		Frequency (MHz)		Channel Number		Frequency (MHz)		Channel Number		Frequency (MHz)					
USA	INT	CAN	Transmit	Receive	USA	INT	CAN	Transmit	Receive	USA	INT	CAN	Transmit	Receive	USA	INT	CAN	Transmit	Receive
	01	01	156.050	160.650	20	20	20*1	157.000	161.600	63A	63A	63A	156.175	156.175		81		157.075	161.675
01A	01A		156.050	156.050	20A	20A		157.000	157.000		64	64	156.225	160.825	81A	81A	81A	157.075	157.075
	02	02	156.100	160.700		20B		RX Only	161.600			64A	156.225	156.225		82		157.125	161.725
	03	03	156.150	160.750		21		157.050	161.650		65		156.275	160.875	82A	82A	82A	157.125	157.125
	04		156.200	160.800	21A	21A	21A	157.050	157.050	65A	65A	65A*1	156.275	156.275		83		157.175	161.775
		04A	156.200	156.200			21B	RX Only	161.650		66		156.325	160.925	83A	83A	83A	157.175	157.175
	05		156.250	160.850		22		157.100	161.700	66A	66A	66A*1	156.325	156.325			83B	RX Only	161.775
05A	05A	05A	156.250	156.250	22A	22A	22A	157.100	157.100	67*2	67	67	156.375	156.375	84		84	157.225	161.825
06	06	06	156.300	156.300		23	23	157.150	161.750	68	68	68	156.425	156.425	85		85	157.275	161.875
	07		156.350	160.950	23A	23A		157.150	157.150	69	69	69	156.475	156.475	86		86	157.325	161.925
07A	07A	07A	156.350	156.350			23B	RX Only	161.750	70*4	70*4	70*4	156.525	156.525	87	87	87	157.375	157.375
08	08	08	156.400	156.400	24		24	157.200	161.800	71	71	71	156.575	156.575	88	88	88	157.425	157.425
09	09	09	156.450	156.450	25		25	157.250	161.850	72	72	72	156.625	156.625					
10	10	10	156.500	156.500			25B	RX Only	161.850	73	73	73	156.675	156.675					
11	11	11	156.550	156.550	26		26	157.300	161.900	74	74	74	156.725	156.725					
12	12	12	156.600	156.600	27	27	27	157.350	161.950		75*1	75*1	156.775	156.775					
13*2	13	13*1	156.650	156.650		27A		157.350	157.350		76*1	76*1	156.825	156.825		1		RX only	162.550
14	14	14	156.700	156.700	28	28	28	157.400	162.000	77*2	77	77*1	156.875	156.875		2		RX only	162.400
15*2*3	15*1	15*1	156.750	156.750			28A	157.400	157.400		78		156.925	161.525		3		RX only	162.475
16	16	16	156.800	156.800			28B	RX Only	162.000	78A	78A	78A	156.925	156.925		4		RX only	162.425
17*1	17	17*1	156.850	156.850		60	60	156.025	160.625		78B		RX Only	161.525		5		RX only	162.450
	18		156.900	161.500		61		156.075	160.675		79		156.975	161.575		6		RX only	162.500
18A	18A	18A	156.900	156.900			61A	156.075	156.075	79A	79A	79A	156.975	156.975		7		RX only	162.525
	19		156.950	161.550		62		156.125	160.725		79B		RX Only	161.575		8		RX only	161.650
19A	19A	19A	156.950	156.950			62A	156.125	156.125		80		157.025	161.625		9		RX only	161.775
	19B		RX Only	161.550		63		156.175	160.775	80A	80A	80A	157.025	157.025		10		RX only	163.275

USA-USA Channel Group, INT-International Channel Group, CAN-Canadian Channel Group *1 Low Power Only. *2 Momentary High Power. *3 Rx Only. *4 DSC Operation Only.

■ SPECIFICATIONS

General	
Frequency Range	TX: 156.000~162.000MHz RX: 156.000~163.425MHz
Modulation	FM (16K0G3E), DSC (16K0G2B)
Frequency Stability	±5ppm
Operating Voltage	DC13.8V (±15%)
Operating Temperature	-20°C~+60°C
Antenna Impedance	50Ω
Dimensions (W×H×D)	155mm×68mm×86mm
Weight	721g (Hand MIC Included)

Transmitter	
Output Power	25W \ 1W
Max. Frequency Deviation	±5kHz
Spurious Emissions	≤ -70dB (H) ≤ -56dB (L)
Adjacent Channel Power	≥ 70dB
Audio Harmonic Distortion	≤ 10%
Current Consumption	≤ 5.5A (H) ≤ 1.5A (L)
Input Impedance	2kΩ (MIC)

Receiver	
Receive Sensitivity	≤ 0.22μV
Squelch Sensitivity	≤ 0.22μV
Adjacent Channel Selectivity	≥ 70dB
Spurious Response Rejection Ratio	≥ 70dB
Intermodulation Rejection Ratio	≥ 70dB
Max. Receive Current	≤ 1.5A
Audio Output Power	≥ 4.5W (10%)
GPS Signal Format	NMEA 0183-2.0
Output Impedance	4Ω (Speaker)

■ TROUBLESHOOTING

The problems described in the following table are some common operating faults. These types of errors are generally caused by improper connections, incorrect operation settings, or operational errors due to incomplete programming. These problems are usually not caused by circuit failures. Before you suspect that the transceiver has malfunctioned, please refer to these tables and relevant parts of this manual.

Problem	Possible Cause	Solution	Ref.
The transceiver does not turn ON.	1. The power cable is not connected well. 2. The power cable fuse is broken. 3. Operating voltage is more than 17V or less than 9V.	1. Check the power cable is connected correctly: red (+); black (-). 2. Find the cause of the blown fuse, replace the new fuse with 15A current. 3. Adjust the power supply to 13.8V.	3
Unable to connect with GPS.	1. Connection error. 2. External GPS format is different.	1. Check the connection is correct. 2. External GPS format should be NMEA 0183-2.0 or 3.01.	3
Unable to scan.	No TAG channel set.	Set the channels you want to scan as TAG channel.	15
Unable to transmit.	Work on Weather Channel or Channel 70 or RX Only Channels.	Exit the weather channel or channel 70 or RX Only Channel, select other channels.	11
Can't select high power.	Some channels can only be transmitted at low power.	Select other channels.	11
Can't communicate on same channel.	1. The channel is duplex (DUP). 2. Working in a self-set channel group.	1. Select channel. 2. Set the channel frequency to the same.	11
No beep.	Beep tones are turned OFF.	Turn the beep tone ON in the Set mode.	47
Distress call cannot be transmitted.	MMSI (DSC self ID) code is not programmed.	While pressing and holding [MENU] , power on to enter MMSI set mode.	18
No sound from the speaker.	1. Squelch level is too high. 2. The volume is too low. 3. Speaker grill water penetration.	1. Press [DIAL] knob twice and rotate to adjust squelch level. 2. Rotate [DIAL] once and rotate to adjust volume. 3. Activate Vibration function to drain water away from speaker.	10, 14

RF ENERGY EXPOSURE AND PRODUCT SAFETY GUIDE FOR PORTABLE TWO-WAY RADIOS



ATTENTION!

Before using this radio, read this guide which contains important operating instructions for safe usage and RF energy awareness and control for compliance with applicable standards and regulations.

This two-way radio uses electromagnetic energy in the radio frequency (RF) spectrum to provide communications between two or more users over a distance. RF energy, which when used improperly, can cause biological damage. All Retevis two-way radios are designed, manufactured, and tested to ensure they meet government-established RF exposure levels. In addition, manufacturers also recommend specific operating instructions to users of two-way radios. These instructions are important because they inform users about RF energy exposure and provide simple procedures on how to control it. Please refer to the following websites for more information on what RF energy exposure is and how to control your exposure to assure compliance with established RF exposure limits: <http://www.who.int/en/>

Local Government Regulations

When two-way radios are used as a consequence of employment, the Local Government Regulations requires users to be fully aware of and able to control their exposure to meet occupational requirements. Exposure awareness can be facilitated by the use of a product label directing users to specific user awareness information. Your Retevis two-way radio has a RF Exposure Product Label. Also, your Retevis user manual, or separate safety booklet includes information and operating instructions required to control your RF exposure and to satisfy compliance requirements.

Radio License

Governments keep the radios in classification, business two-way radios operate on radio frequencies that are regulated by the local radio management departments (FCC, ISED, OFCOM, ANFR, BFTK, Bundesnetzagentur...). To transmit on these frequencies, you are required to have a license issued by them. The detailed classification and the use of your two radios, please contact the local government radio management departments. Use of this radio outside the country where it was intended to be distributed is subject to government regulations and may be prohibited.

Unauthorized modification and adjustment

Changes or modifications not expressly approved by the party responsible for compliance may void the user's authority granted by the local government radio management departments to operate this radio and should not be made. To comply with the corresponding requirements, transmitter adjustments should be made only by or under the supervision of a person certified as technically qualified to perform transmitter maintenance and repairs in the private land mobile and fixed services as certified by an organization representative of the user of those services. Replacement of any transmitter component (crystal, semiconductor, etc.) not authorized by the local government radio management departments equipment authorization for this radio could violate the rules.

FCC Requirements:

This device complies with part 15 of the FCC Rules. Operation is subject to the condition that this device does not cause harmful interference. (Licensed radios are applicable); This device complies with part 15 of the FCC Rules. Operation is subject to the following two conditions:

(Other devices are applicable)

(1) This device may not cause harmful interference, and

(2) this device must accept any interference received, including interference that may cause undesired operation.

NOTE: This equipment has been tested and found to comply with the limits for a Class A digital device, pursuant to part 15 of the FCC Rules. These limits are designed to provide reasonable protection against harmful interference when the equipment is operated in a commercial environment. This equipment generates, uses, and can radiate radio frequency

energy and, if not installed and used in accordance with the instruction manual, may cause harmful interference to radio communications. Operation of this equipment in a residential area is likely to cause harmful interference in which case the user will be required to correct the interference at his own expense.

CE Requirements:

•(Simple EU declaration of conformity) Shenzhen Retevis Technology Co., Ltd. declares that the radio equipment type is in compliance with the essential requirements and other relevant provisions of RED Directive 2014/53/EU and the ROHS Directive 2011/65/EU and the WEEE Directive 2012/19/EU; the full text of the EU declaration of conformity is available at the following internet address: www.retevis.com.

•Restriction Information

This product can be used in EU countries and regions, including: Belgium (BE), Bulgaria (BG), Czech Republic (CZ), Denmark (DK), Germany (DE), Estonia (EE), Ireland (IE), Greece (EL), Spain (ES), France (FR), Croatia (HR), Italy (IT), Cyprus (CY), Latvia (LV), Lithuania (LT), Luxembourg (LU), Hungary (HU), Malta (MT), Netherlands (NL), Austria (AT), Poland (PL), Portugal (PT), Romania (RO), Slovenia (SI), Slovakia (SK), Finland (FI), Sweden (SE) and United Kingdom (UK). For the warning information of the frequency restriction, please refer to the package or manual section.

•Disposal

The crossed-out wheeled-bin symbol on your product, literature, or packaging reminds you that in the European Union, all electrical and electronic products, batteries, and accumulators (rechargeable batteries) must be taken to designated collection locations at the end of their working life. Do not dispose of these products as unsorted municipal waste. Dispose of them according to the laws in your area.

IC Requirements:

Licence-exempt radio apparatus This device contains licence-exempt transmitter(s)/receiver(s) that comply with Innovation, Science and Economic Development Canada's licence-exempt RSS(s). Operation is subject to the following two conditions:

(1) This device may not cause interference.

(2) This device must accept any interference, including interference that may cause undesired operation of the device.

Le présent appareil est conforme aux CNR d'Industrie Canada applicables aux appareils radio exempts de licence. L'exploitation est autorisée aux deux conditions suivantes :

(1) l'appareil ne doit pas produire de brouillage;

(2) l'utilisateur de l'appareil doit accepter tout brouillage radioélectrique subi, même si le brouillage est susceptible d'en compromettre le fonctionnement.

RF Exposure Information

•DO NOT operate the radio without a proper antenna attached, as this may damage the radio and may also cause you to exceed RF exposure limits. A proper antenna is the antenna supplied with this radio by the manufacturer or an antenna specifically authorized by the manufacturer for use with this radio, and the antenna gain shall not exceed the specified gain by the manufacturer declared.

•DO NOT transmit for more than 50% of total radio use time, more than 50% of the time can cause RF exposure compliance requirements to be exceeded.

•During transmissions, your radio generates RF energy that can possibly cause interference with other devices or systems. To avoid such interference, turn off the radio in areas where signs are posted to do so. •DO NOT operate the transmitter in areas that are sensitive to electromagnetic radiation such as hospitals, aircraft, and blasting sites.

•Portable Device, this transmitter may operate with the antenna(s) documented in this filing in Push-to-Talk and body-worn configurations. RF exposure compliance is limited to the specific belt-clip and accessory configurations as documented in this filing and the separation distance between user and the device or its antenna shall be at least 2.5 cm.

•Mobile Device, during operation, the separation distance between user and the antenna subjects to actual regulations, this separation distance will ensure that there is sufficient distance from a properly installed externally-mounted antenna to satisfy the RF exposure requirements.

•Occupational/Controlled Radio, this radio is designed for and classified as "Occupational/Controlled Use Only", meaning it must be used only during the course of employment by individuals aware of the hazards, and the ways to minimize such hazards;

NOT intended for use in a General population/uncontrolled environment.

•General population/uncontrolled Radio, this radio is designed for and classified as "General population/uncontrolled Use".

RF Exposure Compliance and Control Guidelines and Operating Instructions

To control your exposure and ensure compliance with the occupational/controlled environment exposure limits, always adhere to the following procedures.

Guidelines:

•User awareness instructions should accompany the device when transferred to other users.

•Do not use this device if the operational requirements described herein are not met.

Operating Instructions:

•Transmit no more than the rated duty factor of 50% of the time. To Transmit (Talk), push the Push to Talk (PTT) button. To receive calls (listen), release



the PTT button. Transmitting 50% of the time, or less, is important because the radio generates measurable RF energy exposure only when transmitting in terms of measuring for standards compliance.

•Transmit only when people outside the vehicle are at least the recommended minimum lateral distance away from a properly installed according to installation instructions, externally mounted antenna.

•When operating in front of the face, worn on the body, always place the radio in a Retevis approved clip, holder, holster, case, or body harness for this product. Using approved body-worn accessories is important because the use of Non-Retevis approved accessories may result in exposure levels, which exceed the IEEE/ICNIRP RF exposure limits.

Hand-held Mode

• Hold the radio in a vertical position with the microphone (and other parts of the radio including the antenna) at least 2.5 cm (one inch) away from the nose or lips. The antenna should be kept away from the eyes. Keeping the radio at a proper distance is important as RF exposure decreases with increasing distance from the antenna.

Phone Mode

•When placing or receiving a phone call, hold your radio product as you would a wireless telephone. Speak directly into the microphone. Electromagnetic Interference/Compatibility

NOTE: Nearly every electronic device is susceptible to electromagnetic interference (EMI) if inadequately shielded, designed, or otherwise configured for electromagnetic compatibility.

Avoid Choking Hazard



Small Parts. Not for children under 3 years.

Turn off your radio power in the following conditions:



- Turn off your radio before removing (installing) a battery or accessory or when charging battery.
- Turn off your radio when you are in a potentially hazardous environments: Near electrical blasting caps, in a blasting area, in explosive atmospheres (flammable gas, dust particles, metallic powders, grain powders, etc.).
- Turn off your radio while taking on fuel or while parked at gasoline service stations. To avoid electromagnetic interference and/or compatibility conflicts
- Turn off your radio in any facility where posted notices instruct you to do so, hospitals or health care facilities (Pacemakers, Hearing Aids and Other Medical Devices) may be using equipment that is sensitive to external RF energy.
- Turn off your radio when on board an aircraft. Any use of a radio must be in accordance with applicable regulations per airline crew instructions.

Protect your hearing:



- Use the lowest volume necessary to do your job.
 - Turn up the volume only if you are in noisy surroundings.
 - Turn down the volume before adding headset or earpiece.
 - Limit the amount of time you use headsets or earpieces at high volume.
 - When using the radio without a headset or earpiece, do not place the radio's speaker directly against your ear
 - Use careful with the earphone maybe possible excessive sound pressure from earphones and headphones can cause hearing loss
- Note:** Exposure to loud noises from any source for extended periods of time may temporarily or permanently affect your hearing. The louder the radio's volume, the less time is required before your hearing could be affected. Hearing damage from loud noise is sometimes undetectable at first and can have a cumulative effect.



Avoid Burns



Antennas

•Do not use any portable radio that has a damaged antenna. If a damaged antenna comes into contact with the skin when the radio is in use, a minor burn can result.

Batteries (If appropriate)

•When the conductive material such as jewelry, keys or chains touch exposed terminals of the batteries, may complete an electrical circuit (short circuit the battery) and become hot to cause bodily injury such as burns. Exercise care in handling any battery, particularly when placing it inside a pocket, purse or other container with metal objects

Long transmission

•When the transceiver is used for long transmissions, the radiator and chassis will become hot.

Safety Operation



Forbid

- Do not use charger outdoors or in moist environments, use only in dry locations/conditions.
- Do not disassemble the charger, that may result in risk of electrical shock or fire.
- Do not operate the charger if it has been broken or damaged in any way.
- Do not place a portable radio in the area over an air bag or in the air bag deployment area. The radio may be propelled with great force and cause serious injury to occupants of the vehicle when the air bag inflates.

To reduce risk

- Pull by the plug rather than the cord when disconnecting the charger.
- Unplug the charger from the AC outlet before attempting any maintenance or cleaning.
- Contact Retevis for assistance regarding repairs and service.
- The adapter shall be installed near the equipment and shall be easily accessible

Approved Accessories



WARNING

- This radio meets the RF exposure guidelines when used with the Retevis accessories supplied or designated for the product. Use of other accessories may not ensure compliance with the RF exposure guidelines and may violate regulations.
- For a list of Retevis-approved accessories for your radio model, visit the following website: <http://www.Retevis.com>

EU Importer:

Name: Germany Retevis Technology GmbH
Address: Uetzenacker 29,38176 wendeburg

Cut along this line

Guarantee

Model Number: _____ Serial Number: _____

Purchasing Date: _____

Dealer: _____ Telephone: _____

User's _____ Telephone: _____

Country: _____ Address: _____

Post Code: _____ Email: _____

Remarks:

- 1.This guarantee card should be kept by the user, no replacement if lost.
- 2.Most new products carry a two-year manufacturer's warranty from the date of purchase. Further details, pls read <http://www.retevis.com/after-sale/>
- 3.The user can get warranty and after-sales service as below:
 - Contact the seller where you buy.
 - Products Repaired by Our Local Repair Center
- 4.For warranty service, you will need to provide a receipt proof of purchase from the actual seller for verification

Exclusions from Warranty Coverage:

- 1.To any product damaged by accident.
- 2.In the event of misuse or abuse of the product or as a result of unauthorized alterations or repairs.
- 3.If the serial number has been altered, defaced, or removed.